

GASTROENTEROLOGY

1. Multi band ligator
2. Multi band ligator Colonic
3. Sclerotherapy Needle
4. Peg Kit
5. Replacement Peg Tube
6. Foreign Body Holding Forcep
7. Foreign Body Holding Forcep(2-3 Prong)
8. Loop Basket
9. Polypectomy Snare
10. Cleaning Brush
11. Biopsy Forcep
12. Hot Biopsy Forcep
13. Sphincterotome
14. Needle Knife
15. Ball Tip Knife
16. Flexi Knife
17. Hook Knife
18. Hook Knife with flush
19. Endoscopic Scissor
20. Monopolar Probe
21. Retrieval Basket
22. Wire guided Retrieval Basket
23. Tip guided Retrieval Basket
24. Memory Basket
25. Wire guided Memory Basket
26. Litho Basket – TTS
27. Manual Lithotripter
28. Endo Lithotripter
29. Neg guide wire
30. Hydra Neg guide wire
31. Nitinol black wire
32. Stiff guide wire
33. Hyneg combo guide wire
34. Super Stiff Hydra Neg guide wire
35. Stone Extraction Balloon
36. Achalasia Balloon Dilator
37. Esophageal Balloon Dilator
38. Biliary Balloon Dilator
39. 3 stage Balloon Dilator
40. Biliary Stent
41. Biliary Stent Set
42. Single Action Stent Introducer System
43. Single Action Stent Introducer Set
44. Guiding Catheter
45. Stent Pusher
46. Biliary Dilator

47. ERPC Cannula
48. Biliary Metal Stent
49. Pancreatic Basket
50. Choledoch Basket
51. Clipping Device
52. Endoclip Applicator
53. Clips for endoclip
54. Endoknot
55. Suction Coagulation Probe
56. Eus Needle
57. Eus Balloon
58. Cystostome
59. Esophageal Dilator
60. Spring Tip Steel Guide Wire
61. Esophageal Dilator
62. Esophageal Metal Stent
63. Cytology Brush
64. Esophageal Gastric Balloon Retrieval Device
65. Esophageal Gastric Balloon Deflation Device
66. Naso biliary drainage catheter
67. Naso jejunal feeding tube
68. Spray Probe
69. Haemoseal powder device
70. Miscellaneous products

BRONCHOSCOPY

71. Aspiration Needle
72. Biopsy Forcep
73. Cleaning Brush
74. Cytology Brush
75. Foreign Body Holding Forcep

UROLOGY

76. Neg Guide Wire
77. Hydra Neg Guide Wire
78. Hyneg combo guide wire
79. Nitinol Black Wire
80. Stiff Guide Wire
81. Stone Basket
82. Stone Grasper
83. Nephrostomy Basket & Probe

GYNAECOLOGY

84. Cornual Cannulation Set

GASTROENTEROLOGY

GASTROSCOPY ACCESSORIES

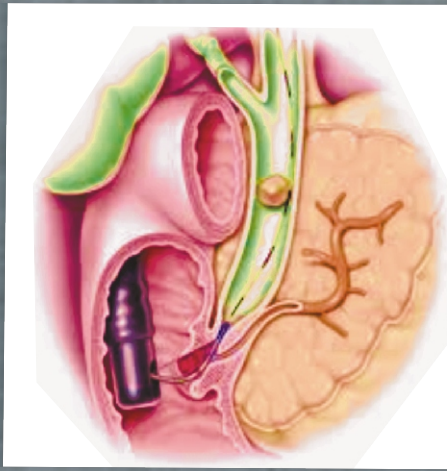
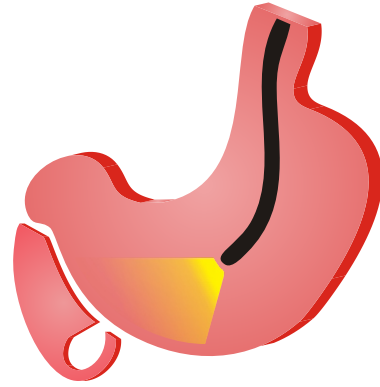

ERCP ACCESSORIES

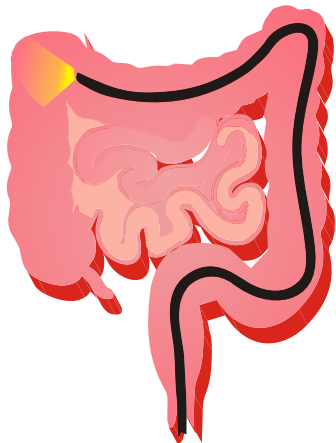

Colonoscopy ACCESSORIES

EUS ACCESSORIES

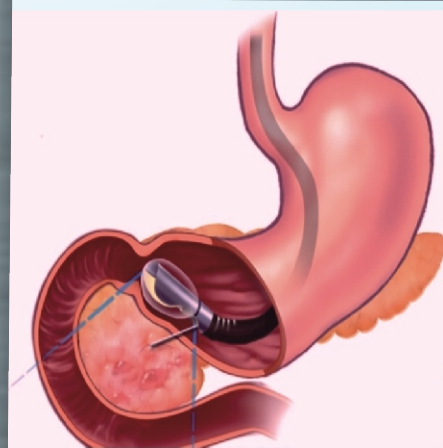

Multi band ligator

Used for Endoscopic Ligation of Esophageal Varices at or above Gastro Esophageal Junction.

This device is supplied Non sterile, individually packed - intended for single use only.

Technical Information :

Shaili Band Ligator requires 9.5 to 11.2 .mm endoscope diameter.

Shaili Paediatric Band Ligator requires 8.0 to 9.5 mm endoscope diameter.

Band Ligator Set Contains

- Applicator x 1 pc., Barrel loaded with 6 x Bands,
- Barrel loaded with 7 x Bands,
- Atraumatic plastic hook with Tube X1pc.,
- Flushing Needle blunt tip x1 pc.
- Second last band with different colour.

Barrel Contains

- Barrel loaded with 6 x Bands,
- Barrel loaded with 7 x Bands,
- Atraumatic plastic hook with Tube X1pc.



Ordering Information- Mention the product code x quantity required.

Reference	Product Name	Reference	Product Name
SBLS-6-F*	MULTI BAND LIGATOR SET	SBLS-6-O*	MULTI BAND LIGATOR SET
SBLS-7-F*	MULTI BAND LIGATOR SET	SBLS-7-O*	MULTI BAND LIGATOR SET
SBL-6-F*	MULTI BAND LIGATOR BARREL	SBL-6-O*	MULTI BAND LIGATOR BARREL
SBL-7-F*	MULTI BAND LIGATOR BARREL	SBL-7-O*	MULTI BAND LIGATOR BARREL
SBLS-6-P-F*	MULTI BAND LIGATOR SET PAEDIATRIC	SBLS-6-P-O*	MULTI BAND LIGATOR SET PAEDIATRIC
SBL-6-P-F*	MULTI BAND LIGATOR BARREL PAEDIATRIC	SBL-6-P-O*	MULTI BAND LIGATOR BARREL PAEDIATRIC

* To Indicate the Length of Thread., F = 175 cm. for Fujinon Endoscope, O = 155 cm. For Olympus / Pentax Endoscope.

Multi band ligator Colonic

Used for Endoscopic Ligation of Colonic Varices.

This device is supplied Non sterile, individually packed - intended for single use only.

Technical Information :

Shaili Band Ligator Colonic requires 12.8 mm to 13.5 mm endoscope diameter.

Band Ligator Colonic Set Contains

- Applicator x 1 pc., Barrel loaded with 6 x Bands,
- Barrel loaded with 7 x Bands,
- Atraumatic plastic hook with Tube X1pc.,
- Flushing Needle blunt tip x1 pc.
- Second last band with different colour.

Barrel Colonic Contains

- Barrel loaded with 6 x Bands,
- Barrel loaded with 7 x Bands,
- Atraumatic plastic hook with Tube X1pc.



Ordering Information- Mention the product code x quantity required.

Reference	Product Name
SBLS-6-C	MULTI BAND LIGATOR COLONIC SET
SBL-6-C	MULTI BAND LIGATOR COLONIC BARREL
SBLS-7-C	MULTI BAND LIGATOR COLONIC SET
SBL-7-C	MULTI BAND LIGATOR COLONIC BARREL

Sclerotherapy Needle

Injector Needles- Sclero Therapy Needle

Used for Endoscopic Injection into Esophageal Varices above O.G.Junction.

Used for Endoscopic injection to introduce a sclerosing agent of vasoconstrictor into selected sites to control actual or potential bleeding lesions. The injection of saline to aid in Endoscopic Mucosal Resection (EMR), Polypectomy procedures and to control non-variceal haemorrhage.

Technical specifications -

Needle - Short and Sharp Bevel, Available in 19/20/21/22/23/24/25 SWG.

Working length - 170 cm. / 230 cm. / 280 cm

Availability -Sterile For Single use only.
Specially Developed Needle To Provide Secure Firm Grip With Inner Tube & Prevent Possible Leakage From The Joint Of Inner Tube & Needle.

Specially Developed Needle Give "JET" Pressure To Inject The Drug for 23/24/25 SWG.

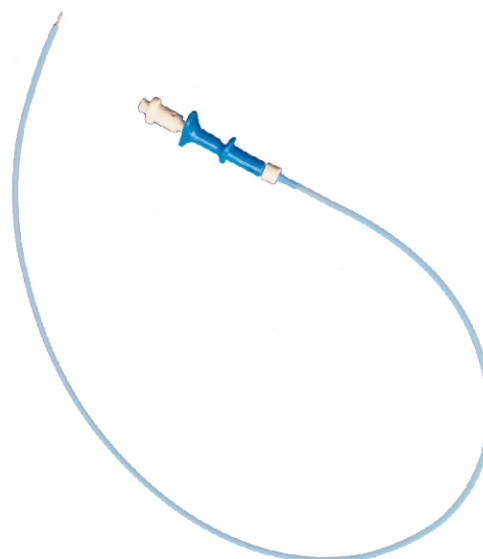

Ordering Information- Mention the product code x quantity required.

Reference	Product Name	Needle Gauge	Working Length	Required Channel Ø
SGN-2319	Sclerotherapy Needle	19G	170 cm	2.8 mm.
SGN-2319-C	Sclerotherapy Needle	19G	230 cm	2.8 mm.
SGN-2320	Sclerotherapy Needle	20G	170 cm	2.8 mm.
SGN-2320-C	Sclerotherapy Needle	20G	230 cm	2.8 mm.
SGN-2321	Sclerotherapy Needle	21G	170 cm	2.8 mm.
SGN-2321-C	Sclerotherapy Needle	21G	230 cm	2.8 mm.
SGN-2321-M	Sclerotherapy Needle Metal Tip	21G	170 cm	2.8 mm.
SGN-2321-C-M	Sclerotherapy Needle Metal Tip	21G	230 cm	2.8 mm.
SGN-2322	Sclerotherapy Needle	22G	170 cm	2.8 mm.
SGN-2322-C	Sclerotherapy Needle	22G	230 cm	2.8 mm.
SSN-2323	Sclerotherapy Needle	23G	170 cm	2.8 mm.
SSN-2323-C	Sclerotherapy Needle	23G	230 cm	2.8 mm.
SSN-2323-M	Sclerotherapy Needle Metal Tip	23G	170 cm	2.8 mm.
SSN-2323-C-M	Sclerotherapy Needle Metal Tip	23G	230 cm	2.8 mm.
SSN-2324	Sclerotherapy Needle	24G	170 cm	2.8 mm.
SSN-2324-C	Sclerotherapy Needle	24G	230 cm	2.8 mm.
SSN-2325	Sclerotherapy Needle	25G	170 cm	2.8 mm.
SSN-2325-C	Sclerotherapy Needle	25G	230 cm	2.8 mm.
SSN-2324-DBE	Sclerotherapy Needle	24G	280 cm	2.8 mm.

PEG KIT

Used for Percutaneous Endoscopic Gastrostomy placement
To provide enteral nutrition to the patient requiring nutritional support.

Technical Information

Size - 20 -22- 24 Fr. Pull technique
Other size can be produced on request.
Availability - Sterile-for single use only.

PEG KIT CONTAINS :

- 1 Silicon feeding tube.
 - 1 Loop insertion wire
 - 1 Cable tie
 - 1 Universal adaptor.
 - 1 Bolus adaptor.
 - 1 Silicon bush for locking.
 - Introducer needle - Big needle
 - 11 No. scalpel
 - 5 ml. Syringe with needle.
 - 25 Gauge needle - Small needle.
 - 1 Scissor.
 - 1 Instruction manual.
- Availability of snare is optional.

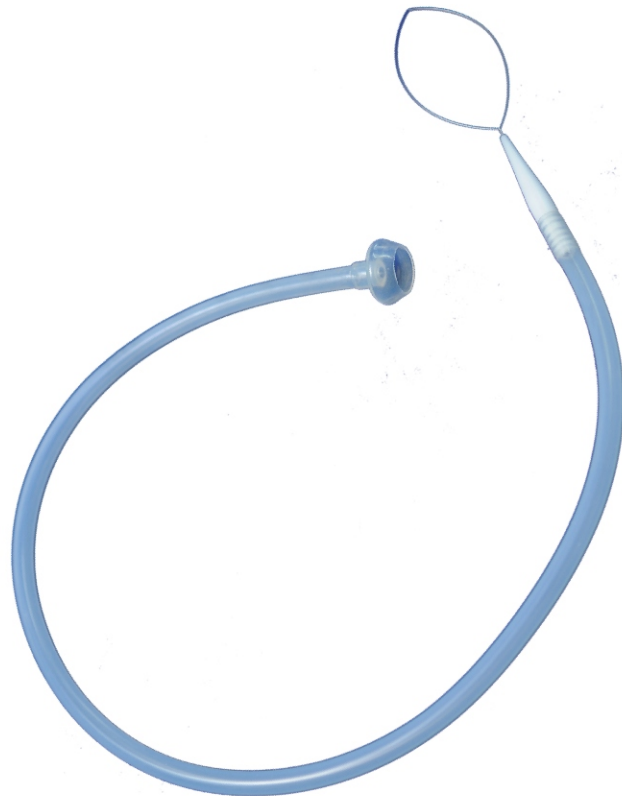

Ordering Information- - Mention product code x quantity required

Reference	Product Name	Size	Remarks
S-PEG-20	PEG KIT	20FR	
S-PEG-20-SN	PEG KIT	20FR	With Snare
S-PEG-22	PEG KIT	22FR	
S-PEG-22-SN	PEG KIT	22FR	With Snare
S-PEG-24	PEG KIT	24FR	
S-PEG-24-SN	PEG KIT	24FR	With Snare

Replacement PEG Tube

Used as a Replacement Gastrostomy Tube through an established Gastrostomy treatment

Technical Information

Size - 20 - 22 - 24 Fr.

Availability - Sterile-for single use only.

1 pc Gastrostomy Replacement Tube

1 pc 12 ml syringe

2 pc 10 ml Normal saline



Ordering Information- - Mention product code x quantity required

Reference	Product Name	Size
S - GRT - 20	Gastrostomy Replacement Tube	20 Fr.
S - GRT - 22	Gastrostomy Replacement Tube	22 Fr.
S - GRT - 24	Gastrostomy Replacement Tube	24 Fr.

Foreign Body Holding Forcep

Used to retrieve foreign body from G.I. Tract.

Shark Tooth Forcep.
Alligator Forcep.
Shark Tooth Alligator Forcep.

Features :

Can be used with ERCP Scope to Retrieve stent.(Shark Tooth Forcep Only).
Supplied Without Sterile and it is Reusable.
Specially produced outer sheath for easy elevation through elevator. (Shark Tooth Forcep Only)
Firm grip & easy movement.

Rotatable graspers are available

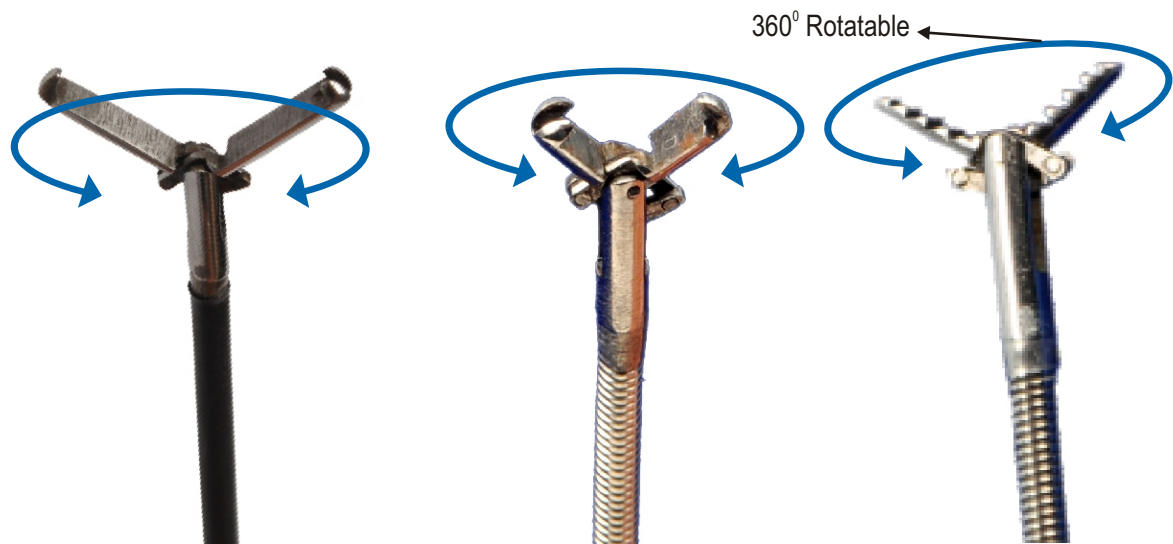

Ordering Information- Mention the product code x quantity required.

Reference	Product Name	Required Channel Ø	Jaws Specification	Working Length
SSTF-230	SHARK TOOTH FORCEP	2.8 mm.	Rat Tooth Jaws	230 cm
SSTF-170	SHARK TOOTH FORCEP	2.8 mm.	Rat Tooth Jaws	170 cm
SATF-230	ALLIGATOR FORCEP	2.8 mm.	Alligator Jaws	230 cm
SATF-170	ALLIGATOR FORCEP	2.8 mm.	Alligator Jaws	170 cm
SSTF-230-R	SHARK TOOTH FORCEP ROTATABLE	2.8 mm.	Rat Tooth Jaws	230 cm
SSTF-170-R	SHARK TOOTH FORCEP ROTATABLE	2.8 mm.	Rat Tooth Jaws	170 cm
SATF-230-R	ALLIGATOR FORCEP ROTATABLE	2.8 mm.	Alligator Jaws	230 cm
SATF-170-R	ALLIGATOR FORCEP ROTATABLE	2.8 mm.	Alligator Jaws	170 cm
SSAF-230	SHARK TOOTH ALLIGATOR COMBO	2.8 mm.	Combo	230 cm
SSAF-170	SHARK TOOTH ALLIGATOR COMBO	2.8 mm.	Combo	170 cm
SSAF-230-R	SHARK TOOTH ALLIGATOR COMBO ROTATABLE	2.8 mm.	Combo	230 cm
SSAF-170-R	SHARK TOOTH ALLIGATOR COMBO ROTATABLE	2.8 mm.	Combo	170 cm

“Shaili “ Range of Foreign Body Holder : 2 prong , 3 Prong , Retrieval Basket, Snare, Shark Tooth Forcep, Alligator Forcep, Monofilament Memory Basket, Loop Basket.

Foreign Body Holding Forcep 2 Prong, 3 Prong

Used to retrieve Foreign body from G.I. Tract.

Technical Information :

Compatible with 2.0 & 2.8 mm. instrument channel.

Working length 170 cm. / 230 cm.

Supplied Non Sterile and It is Reusable.

Excellent and secure grip to retrieve Foreign

Body from G.I. Tract.

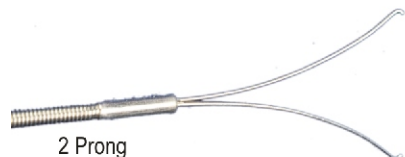

Ordering Information- Mention the product code x quantity required.

Reference	Product Name	Working Length	Required Channel Ø	Jaws
SFBH-223	F B HOLDER 2 PRONG	170 cm	2.8 mm	2 Prong
SFBH-218	F B HOLDER 2 PRONG	170 cm	2.0 mm	2 Prong
SFBH-323	F B HOLDER 3 PRONG	170 cm	2.8 mm	3 Prong
SFBH-318	F B HOLDER 3 PRONG	170 cm	2.0 mm	3 Prong
SFBH-423	F B HOLDER 4 PRONG	170 cm	2.8 mm	4 Prong
SFBH-223-C	F B HOLDER 2 PRONG	230 cm	2.8 mm	2 Prong
SFBH-218-C	F B HOLDER 2 PRONG	230 cm	2.0 mm	2 Prong
SFBH-323-C	F B HOLDER 3 PRONG	230 cm	2.8 mm	3 Prong
SFBH-423-C	F B HOLDER 4 PRONG	230 cm	2.8 mm	4 Prong

“Shaili “ Range of Foreign Body Holder : 2 prong , 3 Prong , Retrieval Basket, Snare, Shark Tooth Forcep, Alligator Forcep, Monofilament Memory Basket, Loop Basket.

Loop Basket

Used for Endoscopic retrieval of Foreign Bodies from the GI Tract and to retrieve Polyp through Colono Scope.

Technical Information

Shape : Oval

With flush port.

Availability - Non sterile and for single use only.

Loop Diameter \geq 61 mm could be with 2 hand operation handle

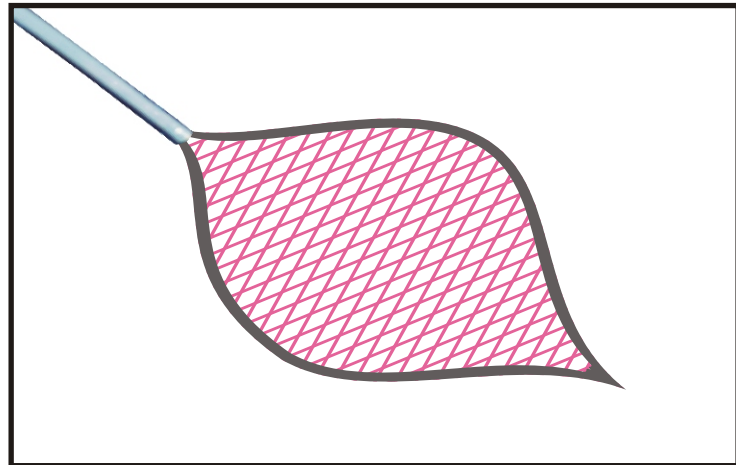
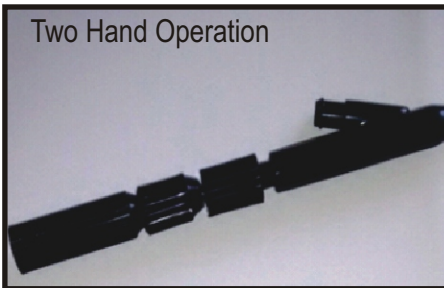

Ordering Information- - Mention product code x quantity required

Reference	Product Name	Required Channel \emptyset	Loop Size	Length
SFBH-L-30	LOOP BASKET	2.8mm	30mm	170cm
SFBH-L-40	LOOP BASKET	2.8mm	40mm	170cm
SFBH-L-60	LOOP BASKET	2.8mm	60mm	170cm
SFBH-L-90	LOOP BASKET	2.8mm	90mm	170cm
SFBH-L-C-30	LOOP BASKET	2.8mm	30mm	230cm
SFBH-L-C-40	LOOP BASKET	2.8mm	40mm	230cm
SFBH-L-C-60	LOOP BASKET	2.8mm	60mm	230cm
SFBH-L-C-90	LOOP BASKET	2.8mm	90mm	230cm
SFBH-LB-DBE-60	LOOP BASKET	2.8mm	60mm	280cm

Polypectomy Snare

Used for Endoscopic Excision of polyps using monopolar electrosurgical unit and retrieval of foreign bodies from G.I. tract.

Technical Information

Availability - Sterile for Single use only.

With flush port to clean wire during procedure.

Outer sheath - PTFE.

Loop Diameter - 6 - 10 - 13 - 15 - 20 - 25 - 30 - 35 - 40 - 45 - 50 - 55 mm

Loop Diameter for Duckbill Snare is 25 mm only

Shape - Hexagonal / Oval / Crescent / Duckbill available in Multifilament

Monofilament available in only Oval shape

Individually packed .

Rotatable Snare is available

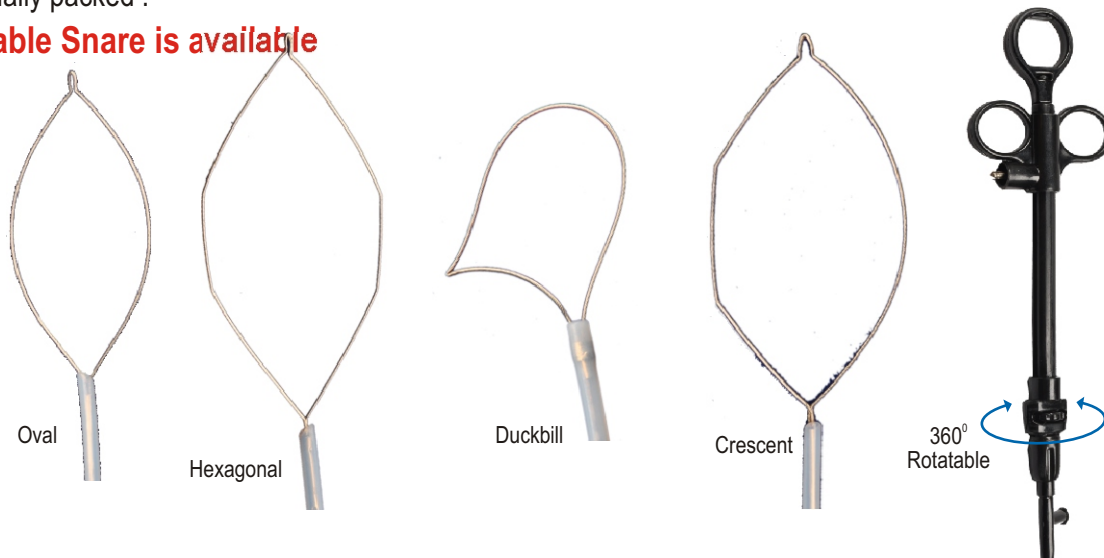

Ordering Information- Mention the product code x Loop Diameter x quantity required.

Example : Polypectomy Snare Oval X 30mm loop = SPSO-30

Polypectomy Snare Oval x 20mm loop x Rotatable =SPSO-20-R

Reference	Product Name	Length	Shape	Required Channel Ø
SPSO - Loop Ø	Polypectomy Snare	220 cm	OVAL	2.8 mm
SPSH - Loop Ø	Polypectomy Snare	220 cm	HEXAGONAL	2.8 mm
SPSC - Loop Ø	Polypectomy Snare	220 cm	CRESCENT	2.8 mm
SPSD - 25	Polypectomy Snare	220 cm	DUCKBILL	2.8 mm
SPSM - Loop Ø	Polypectomy Snare	220 cm	MONOFILAMENT	2.8 mm
SPSO - Loop Ø-R	Polypectomy Snare Rotatable	220 cm	OVAL	2.8 mm
SPSH - Loop Ø-R	Polypectomy Snare Rotatable	220 cm	HEXAGONAL	2.8 mm
SPSC - Loop Ø-R	Polypectomy Snare Rotatable	220 cm	CRESCENT	2.8 mm
SPSM - Loop Ø-R	Polypectomy Snare Rotatable	220 cm	MONOFILAMENT	2.8 mm
SPSO - 30 - DBE	Polypectomy Snare Rotatable	280 cm	OVAL	2.8 mm

Tailormade device can be produced provided by pre approved drawing/ specification

Cleaning Brush

Used to clean endoscope channel.

Technical Information

Type - Non sterile single use / Reusable.

Shaft - Plastic coated wire/ Metal coil.

Semi - Soft and channel friendly bristles for Without invasive cleaning of endoscope channel.

Tip - Atraumatic.

Length - 120 cm / 180 cm /230 cm.

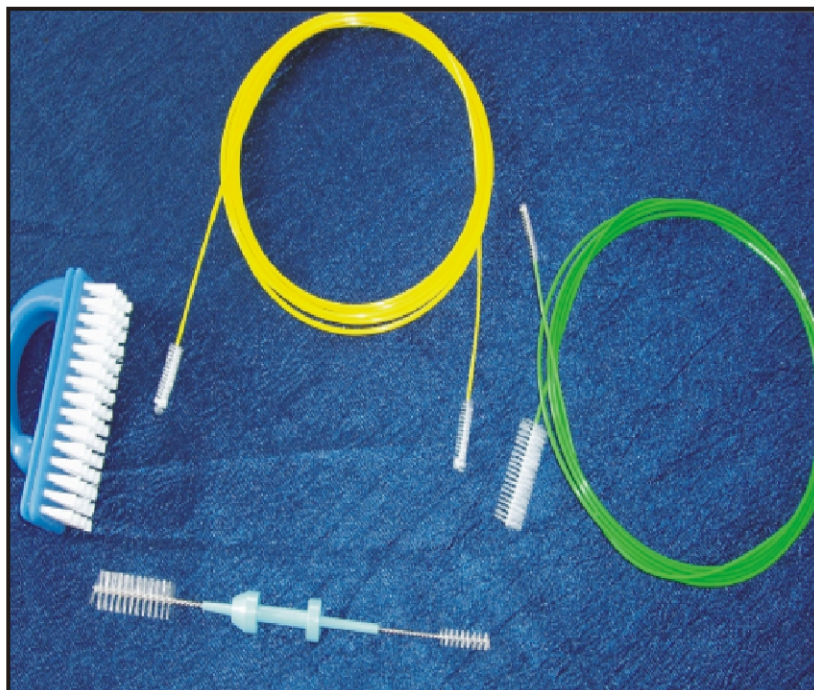

Ordering Information- Mention the product code x quantity required.

Reference	Product Name	Required Channel Ø	Working Length
S - CB - DE	Cleaning Brush Double Ended	2.8 mm.	230 cm
S - CB - DE - BS	Cleaning Brush Double Ended Big-Small	2.8 mm.	230 cm
S - CB - P	Port Cleaning Brush	-	-
S - CB - B	Body Cleaning Brush	-	-
S - CB - RG	Cleaning Brush Reusable Gastro	2.8 mm.	180 cm
S - CB - RC	Cleaning Brush Reusable Colono	2.8 mm.	230 cm
S - CB - D	Cleaning Brush for Dilator	1.2 mm.	120 cm

Biopsy Forcep

Used Endoscopically to obtain Mucosal Tissue Samples from Gastrointestinal Tract for Microscopic - Histopathological Examination.

Technical Information

Type - With Spike / Without Spike.

Availability - Sterile, For Single use only.

Compatible with 2.8 & 2.0 mm instrument channel.

Length - 170 cm & 210 cm.

Individually packed.

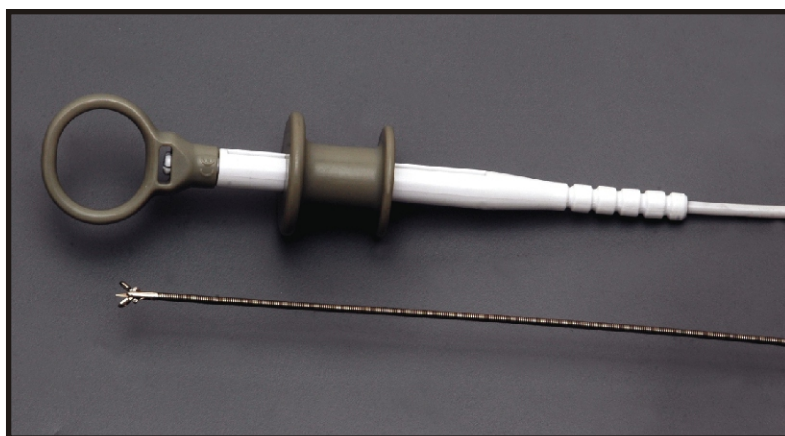

Ordering Information- Mention the product code x quantity required.

Reference	Product Name	Type	Required Channel Ø	Working Length
S- BF- WS-17	Biopsy Forcep	With Spike	2.8 mm	170 cm
S- BF- WS-21	Biopsy Forcep	With Spike	2.8 mm	210 cm
S- BF- 17	Biopsy Forcep	Without Spike	2.8 mm	170 cm
S- BF- 21	Biopsy Forcep	Without Spike	2.8 mm	210 cm

Hot Biopsy Forcep

Used endoscopically to obtain mucosal tissue samples from Gastrointestinal tract for microscopic- Histopathological Examination

Monopolar electro surgical unit can be used to cauterize the tissue when bleeding occurs during tissue sampling

Technical Information

Without Spike

Availability- Sterile, for single use

Compatible with 2.8 instrument channel

Working Length- 170, 210cm

Active cord available separately.

Individually packed

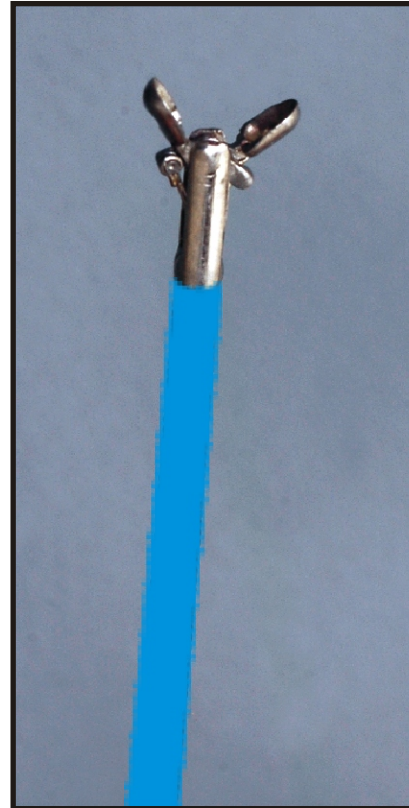

Ordering Information- Mention the product code x quantity required.

Reference	Product Name	Type	Required Channel Ø	Working Length
S- BF-H-17	Hot Biopsy Forcep	Without Spike	2.8 mm	170 cm
S- BF-H-21	Hot Biopsy Forcep	Without Spike	2.8 mm	210 cm

Sphincterotome

Used for Endoscopic Cannulation of Biliary Ductal System and Sphincterotomy.

Technical Information

Triple Lumen with Precurved tapered tip.

Tip diameter 5.5fr.

Working length 200 cm.

Wire Guide Compatibility 0.035"

Cutting wire with or without insulation as required

Protective insulation sheath, unique protective feature for endoscope,

Insulated wire length - for 20mm Loop - 4 mm, 25mm Loop - 8mm, 30 mm Loop - 10mm

Supplied Sterile for single use.

Active Cord available separately.

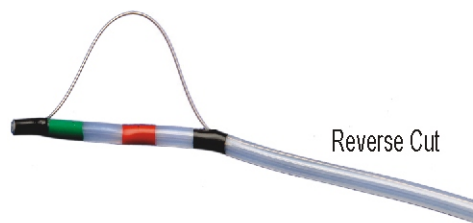

Ordering Information- Mention the product code x quantity required.

Reference	Product Name	Tip length	Total Loop	With / Without Insulation
SSPH-SN-20	Sphincterotome Short Nose	5.0mm	20mm	With Insulation
SSPH-SN-25	Sphincterotome Short Nose	5.0mm	25mm	With Insulation
SSPH-SN-30	Sphincterotome Short Nose	5.0mm	30mm	With Insulation
SSPH-SN-NI-20	Sphincterotome Short Nose	5.0mm	20mm	Without Insulation
SSPH-SN-NI-25	Sphincterotome Short Nose	5.0mm	25mm	Without Insulation
SSPH-SN-NI-30	Sphincterotome Short Nose	5.0mm	30mm	Without Insulation
SSPH-LN-20	Sphincterotome Long Nose	8.0mm	20mm	With Insulation
SSPH-LN-25	Sphincterotome Long Nose	8.0mm	25mm	With Insulation
SSPH-LN-30	Sphincterotome Long Nose	8.0mm	30mm	With Insulation
SSPH-LN-NI-20	Sphincterotome Long Nose	8.0mm	20mm	Without Insulation
SSPH-LN-NI-25	Sphincterotome Long Nose	8.0mm	25mm	Without Insulation
SSPH-LN-NI-30	Sphincterotome Long Nose	8.0mm	30mm	Without Insulation
SSPH-NN-20	Sphincterotome No Nose	0.0mm	20mm	With Insulation
SSPH-NN-25	Sphincterotome No Nose	0.0mm	25mm	With Insulation
SSPH-NN-30	Sphincterotome No Nose	0.0mm	30mm	With Insulation
SSPH-NN-NI-20	Sphincterotome No Nose	0.0mm	20mm	Without Insulation
SSPH-NN-NI-25	Sphincterotome No Nose	0.0mm	25mm	Without Insulation
SSPH-NN-NI-30	Sphincterotome No Nose	0.0mm	30mm	Without Insulation
SSPH-RC-NI-20	Sphincterotome Reverse Cut	2.0mm	20mm	Without Insulation
SSPH-RC-NI-25	Sphincterotome Reverse Cut	2.0mm	25mm	Without Insulation
SSPH-RC-NI-30	Sphincterotome Reverse Cut	2.0mm	30mm	Without Insulation
SSPH-SN-20-DBE	Sphincterotome Short Nose 280 cm.long	5.0mm	20mm	With Insulation
SSPH-SN-25-DBE	Sphincterotome Short Nose 280 cm.long	5.0mm	25mm	With Insulation
SSPH-SN-30-DBE	Sphincterotome Short Nose 280 cm long	5.0mm	30mm	With Insulation
SSPH-LN-20-DBE	Sphincterotome Long Nose 280 cm.long	8.0mm	20mm	With Insulation
SSPH-LN-25-DBE	Sphincterotome Long Nose 280 cm.long	8.0mm	25mm	With Insulation
SSPH-LN-30-DBE	Sphincterotome Long Nose 280 cm.long	8.0mm	30mm	With Insulation

Needle Knife

Used for Precut Papillotomy.

Technical Information

Tapered tip.

Individually packed.

Supplied Sterile and it is for single use.

Active Cord available separately.

Wire Guided Needle Knife accept 0.035" Guide Wire

Needle Knife



Wire Guided Needle Knife



Ordering Information- Mention the product code x quantity required.

Reference	Product Name	Length	Needle Length	Outer Ø
SNK-100	Needle Knife	200 cm	5 mm	1.7 mm
SNK-100-DL	Wire Guided Needle Knife	200 cm	5 mm	2.45 mm
SNK-100-DBE	Needle Knife Double Balloon Endoscope	280 cm	5 mm	1.7 mm
SNK-100-DL-DBE	Needle Knife Double Balloon Endoscope	280cm	5 mm	2.45 mm

Ball Tip Knife

For smooth incision and cutting during EMR and ESD endoscopy procedure

Technical Information

Working Length 180cm

Individually packed

Supplied sterile and it is for single use

Active Cord available separately



Ordering Information- Mention the product code x quantity required.

Reference	Product Name	Length	Needle Length	Outer Ø
SNK - IP	Ball Tip Knife	180cm	7 mm	2.5 mm

Flexi Knife

For smooth incision and cutting during EMR and ESD endoscopy procedure

Technical Information

Working Length 180cm

Individually packed

Supplied sterile and it is for single use

Active Cord available separately

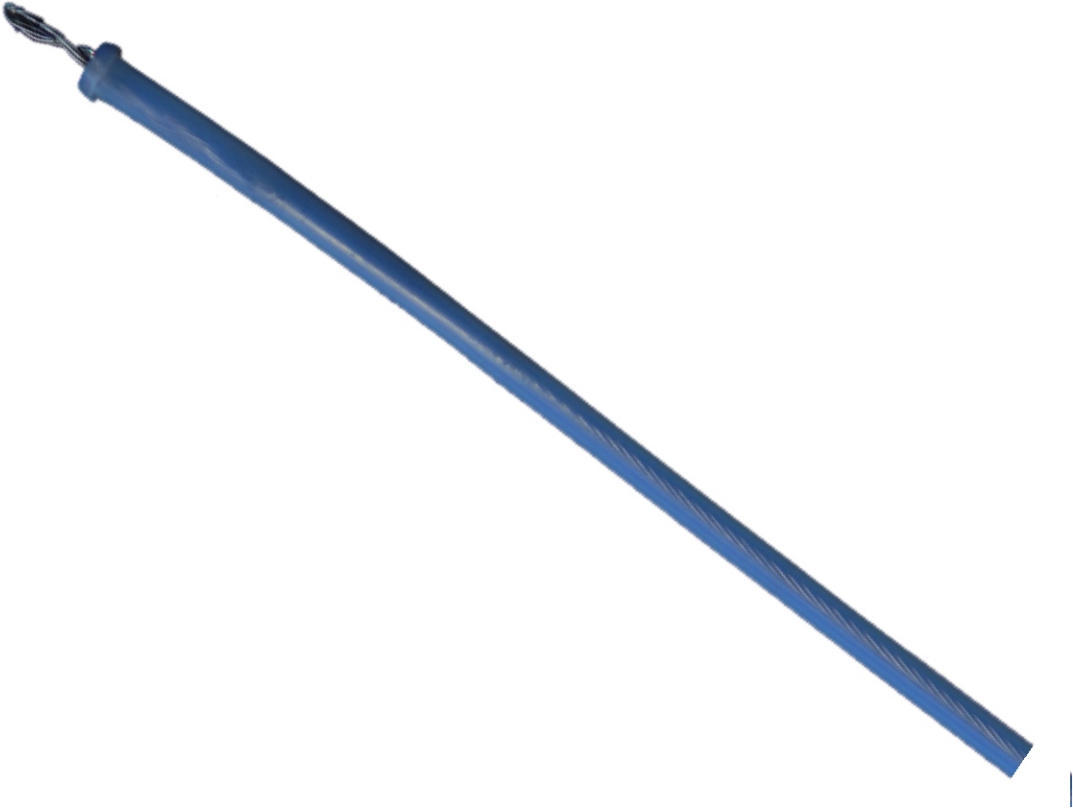

Ordering Information- Mention the product code x quantity required.

Reference	Product Name	Length	Needle Length	Outer Ø
SNK-XP	FLEXI KNIFE	180cm	7 mm	2.0 mm

Hook Knife

For smooth incision and cutting during EMR and ESD endoscopy procedure

Technical Information

Working Length 180cm

Individually packed

Supplied sterile and it is for single use

Active Cord available separately



Ordering Information- Mention the product code x quantity required.

Reference	Product Name	Length	Needle Length	Outer Ø
SNK-X	Hook Knife	180cm	7 mm	2.5mm

Hook Knife with flush

For smooth incision and cutting during EMR and ESD endoscopy procedure

Technical Information

Working Length 180cm

With flush port

Individually packed

Supplied sterile and it is for single use

Active Cord available separately

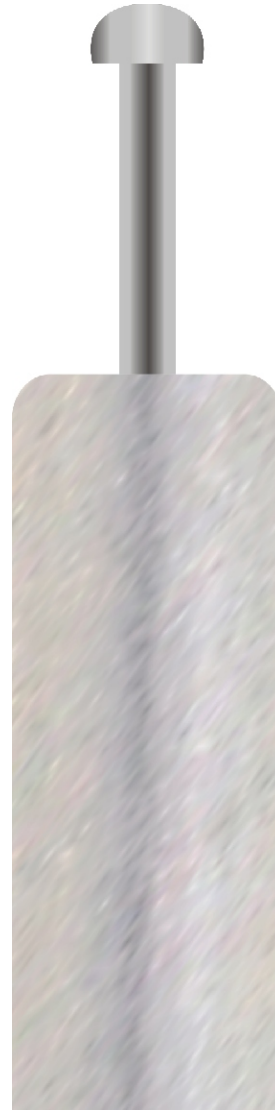

Ordering Information- Mention the product code x quantity required.

Reference	Product Name	Length	Needle Length	Sheath Ø
SNK-X-F	Hook Knife with Flush	180 cm	7 mm	2.0 mm

Endoscopic Scissor

Used to cut and coagulate during endoscopic mucosal resection.

Technical Information

Working length 160/230cm

Sheath diameter 2.5 mm

Availability - Sterile for single use only.

Rotatable scissor is available

Active Cord available separately



Ordering Information : Mention the product code x quantity required.

Reference	Product Name	Length	Sheath Diameter
S-ES-160-H	ENDO SCISSOR HOT	160cm	2.5mm
S-ES-160-R-H	ENDO SCISSOR HOT ROTATABLE	160cm	2.5mm
S-ES-230-H	ENDO SCISSOR HOT	230cm	2.5 mm
S-ES-230-R-H	ENDO SCISSOR HOT ROTATABLE	230cm	2.5 mm

Monopolar Probe

For Monopolar Cutting and coagulation through Endoscope

Technical Information

Working length 230cm

Sheath diameter 2.3 mm

Availability - Sterile for single use only.

Active cord available separately



Ordering Information : Mention the product code x quantity required.

Reference	Product Name	Length	Sheath Diameter
SMP	MONOPOLAR PROBE	230cm	2.3 mm

Retrieval Basket

Used to retrieve Foreign Bodies and C.B.D. stones endoscopically

Technical Information :

Compatible with instrument channel \geq 2.8 mm.

Basket diameter - 15 mm. / 20 mm. / 25 mm. / 30 mm. / 35 mm. / 40 mm. / 45 mm. / 50 mm.

Multifilament, Hexagonal shaped.

Flush port for contrast.

Atraumatic basket tip for ease of insertion and procedure.

Compatible with Lithotripter.

Sterile for single use only.

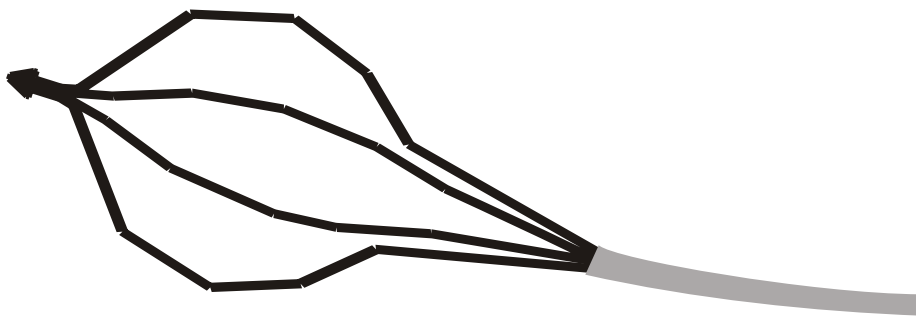

Ordering Information- Strand diameter is 0.41mm, Working length 230 cm.

Reference	Product Name	Basket Ø	Required Channel Ø	Working Length
SRB-4152	Retrieval Basket	15 mm.	2.8 mm.	230 cm.
SRB-4202	Retrieval Basket	20 mm.	2.8 mm.	230 cm.
SRB-4252	Retrieval Basket	25 mm.	2.8 mm.	230 cm.
SRB-4302	Retrieval Basket	30 mm.	2.8 mm.	230 cm.
SRB-4352	Retrieval Basket	35 mm.	2.8 mm.	230 cm.
SRB-4402	Retrieval Basket	40 mm.	2.8 mm.	230 cm.
SRB-4452	Retrieval Basket	45 mm.	2.8 mm.	230 cm.
SRB-4502	Retrieval Basket	50 mm.	2.8 mm.	230 cm.
SRB-4302-DBE	Retrieval Basket	30 mm.	2.8 mm.	280 cm.

Tailormade device can be produced provided by pre approved drawing/ specification

Wire guided Retrieval Basket

Used to retrieve Foreign Bodies and C.B.D. stones Endoscopically.

Technical Information :

- Working length 230 cm.
- Separate lumen for wire.
- Compatible with instrument channel 3.2 mm.
- Basket diameter -15mm. / 20 mm. / 25mm. / 30 mm./35 mm.
40 mm./ 45 mm./ 50 mm.
- Multifilament, Hexagonal shaped.
- Flush port for contrast.
- Atraumatic basket tip for ease of insertion and procedure.

Compatible with Lithotripter.

Sterile for single use only.



Ordering Information- Strand diameter is 0.41mm, Working length 230 cm.

Reference	Product Name	Basket Ø	Sheath Ø	Wire Guide Compatibility
SRB-WG-4153	Wire Guided Retrieval Basket	15 mm	3.0 mm.	0.035"
SRB-WG-4203	Wire Guided Retrieval Basket	20 mm	3.0 mm.	0.035"
SRB-WG-4253	Wire Guided Retrieval Basket	25 mm	3.0 mm.	0.035"
SRB-WG-4303	Wire Guided Retrieval Basket	30 mm	3.0 mm.	0.035"
SRB-WG-4353	Wire Guided Retrieval Basket	35 mm	3.0 mm.	0.035"
SRB-WG-4403	Wire Guided Retrieval Basket	40 mm	3.0 mm.	0.035"
SRB-WG-4453	Wire Guided Retrieval Basket	45 mm	3.0 mm.	0.035"
SRB-WG-4503	Wire Guided Retrieval Basket	50 mm	3.0 mm.	0.035"

Tailormade device can be produced provided by pre approved drawing/ specification

Tip guided Retrieval Basket

Used to retrieve Foreign Bodies and C.B.D. stones endoscopically

Technical Information :

Working length 230 cm.

Wire access point on tip of basket.

Compatible with instrument channel 2.8 mm or more.

Basket diameter -15mm. / 20 mm. / 25mm. / 30 mm. / 35 mm. / 40 mm. / 45 mm. / 50 mm.

Multifilament, Hexagonal shaped.

Flush port for contrast.

Compatible with Lithotripter.

Sterile for single use only.

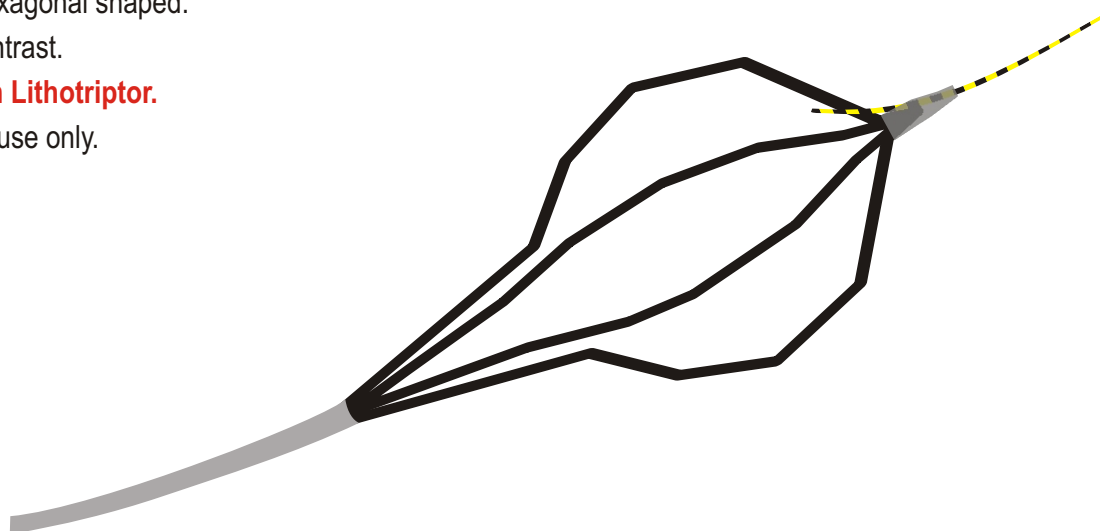

Ordering Information- Strand diameter is 0.41mm, Working length 230 cm.

Reference	Product Name	Basket Ø	Sheath Ø	Wire Guide Compatibility
SRB-WG-4152-T	Tip Guided Retrieval Basket	15 mm	2.5 mm.	0.035"
SRB-WG-4202-T	Tip Guided Retrieval Basket	20 mm	2.5 mm.	0.035"
SRB-WG-4252-T	Tip Guided Retrieval Basket	25 mm	2.5 mm.	0.035"
SRB-WG-4302-T	Tip Guided Retrieval Basket	30 mm	2.5 mm.	0.035"
SRB-WG-4352-T	Tip Guided Retrieval Basket	35 mm	2.5 mm.	0.035"
SRB-WG-4402-T	Tip Guided Retrieval Basket	40 mm	2.5 mm.	0.035"
SRB-WG-4452-T	Tip Guided Retrieval Basket	45 mm	2.5 mm.	0.035"
SRB-WG-4502-T	Tip Guided Retrieval Basket	50 mm	2.5 mm.	0.035"

Tailormade device can be produced provided by pre approved drawing/ specification

Memory Basket

Used to retrieve foreign body / Stone from G.I.Tract - through the scope.

Technical Information

Seven basket sizes to facilitate foreign body retrieval from G.I.Tract / stone retrieval from bileduct.

Basket Type - Oval, Hexagonal, Tipless & Helical

Retains shape for longer time.

Handle - Light weight with flush port for contrast.

Not recommended for Lithotripsy.

Availability - Sterile - for single use only

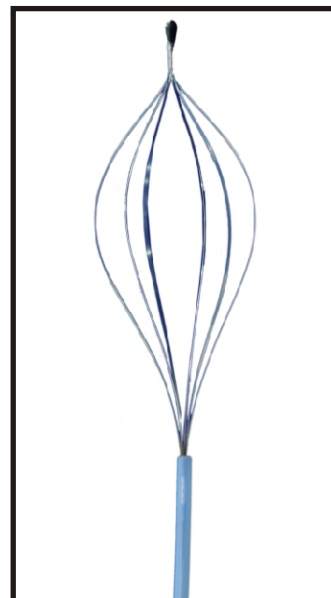

Ordering Information- Mention the product code x quantity required.

Reference	Product Name	Required Channel Ø	Basket Ø	Working Length
SMMB-15	Memory Basket	2.8mm	15mm	230cm
SMMB-20	Memory Basket	2.8mm	20mm	230cm
SMMB-25	Memory Basket	2.8mm	25mm	230cm
SMMB-30	Memory Basket	2.8mm	30mm	230cm
SMMB-35	Memory Basket	2.8mm	35mm	230cm
SMMB-40	Memory Basket	2.8mm	40mm	230cm
SMMB-45	Memory Basket	2.8mm	45mm	230cm
SMMB-15-T	Memory Tipless Basket	2.8mm	15mm	230cm
SMMB-20-T	Memory Tipless Basket	2.8mm	20mm	230cm
SMMB-25-T	Memory Tipless Basket	2.8mm	25mm	230cm
SMMB-30-T	Memory Tipless Basket	2.8mm	30mm	230cm
SMMB-35-T	Memory Tipless Basket	2.8mm	35mm	230cm
SMMB-40-T	Memory Tipless Basket	2.8mm	40mm	230cm
SMMB-45-T	Memory Tipless Basket	2.8mm	45mm	230cm

Tailormade device can be produced provided by pre approved drawing/ specification

Wire Guided Memory Basket

Used to retrieve foreign body / Stone from G.I.Tract - through the scope.

Technical Information

Three basket sizes to facilitate stone retrieval from biliary tract.

Basket shapes - Oval, Hexagonal.

Retains shape for longer time.

Handle - Light weight with flush port for contrast.

Centre port for guide wire

Wire guide compatibility 0.035"

Not recommended for Lithotripsy.

Availability - Sterile - for single use only

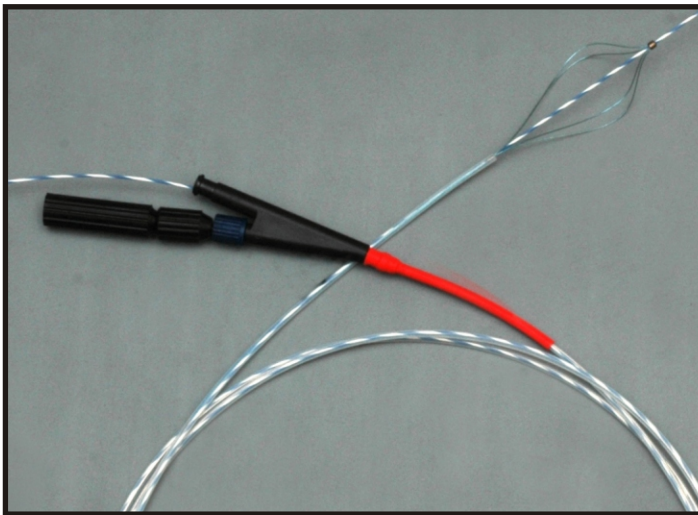

Ordering Information- Mention the product code x quantity required.

Reference	Product Name	Required Channel Ø	Basket Ø	Working Length
SMMB-WG-30	Memory Basket Wire Guided	2.8mm	30mm	230cm
SMMB-WG-35	Memory Basket Wire Guided	2.8mm	35mm	230cm
SMMB-WG-40	Memory Basket Wire Guided	2.8mm	40mm	230cm

Tailormade device can be produced provided by pre approved drawing/ specification

Litho Basket-TTS

Used for purpose of CBD stone retrieval/ lithotripsy of stone in bile duct through the scope

Technical Specification :

Working length 230cm

Extension wire length 205cm

Loop Diameter 25/30/35/40/45/50/55mm

Sheath Diameter 2.5mm

Recommended for manual lithotripsy.

Supplied sterile and it is for single use

Detachable Handle.

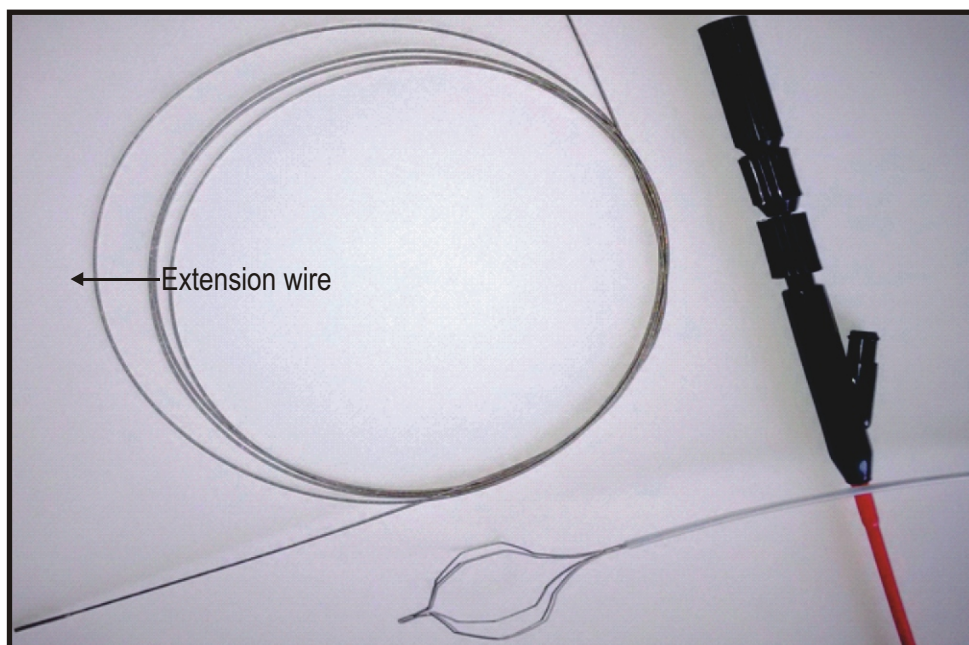

Ordering Information- Mention the product code x quantity required.

Reference	Product Name	Basket Ø	Sheath Ø	Working Length
SLTB-25	Lithotripsy Basket TTS	25mm	2.5mm	230cm
SLTB-30	Lithotripsy Basket TTS	30mm	2.5mm	230cm
SLTB-35	Lithotripsy Basket TTS	35mm	2.5mm	230cm
SLTB-40	Lithotripsy Basket TTS	40mm	2.5mm	230cm
SLTB-45	Lithotripsy Basket TTS	45mm	2.5mm	230cm
SLTB-50	Lithotripsy Basket TTS	50mm	2.5mm	230cm
SLTB-55	Lithotripsy Basket TTS	55mm	2.5mm	230cm

Manual Lithotripter

Used For C.B.D. Stone Lithotripsy.

Technical Information

Handle - Light weight with unidirectional movement.

Sheath tip - Inner cutting edges to perform lithotripsy. Outer tip rounded atraumatic.

Secure and firm fitting of S.S. Sheath with handle to facilitate retrieval - lithotripsy procedure.

Availability - Non Sterile Reusable.

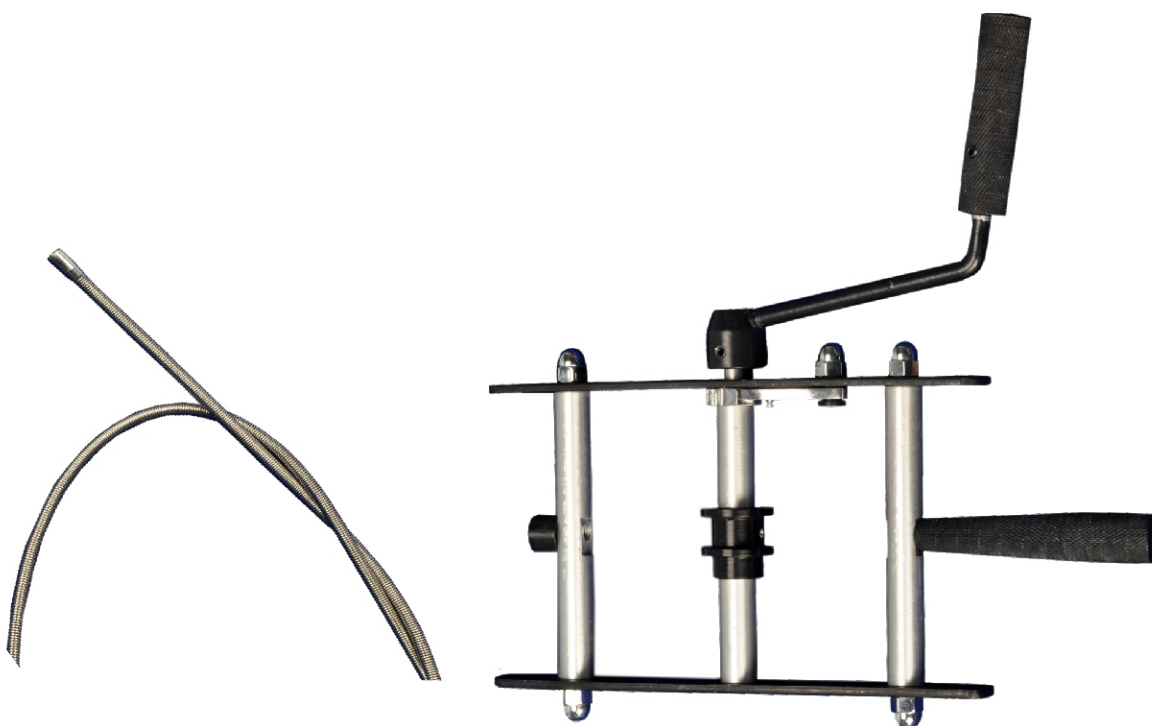

Ordering Information- Mention the product code x quantity required.

Reference	Product Name	Spring Sheath \emptyset	Spring Sheath Length	Required Channel \emptyset
SML-SHEATH-16590	Manual Lithotripter Spring Sheath	16.5FR	90cm	NA
SML-SHEATH-1190	Manual Lithotripter Spring Sheath	11 FR	90cm	NA
SML-SHEATH-11180-TTS	Manual Lithotripter TTS Spring Sheath	11 FR	180cm	4.2mm
SML-SHEATH-75180-TTS	Manual Lithotripter TTS Spring Sheath	7.5 FR	180cm	2.8mm
SML-SHEATH-9180-TTS	Manual Lithotripter TTS Spring Sheath	9 FR	180cm	3.2mm
SML-H	Manual Lithotripter Handle only			

Endo Lithotripter

Used for Purpose Of C.B.D. Stone Retrieval through the Scope.
And for Lithotripsy to Crush Stones in Biliary Duct.

Features :

- | | |
|-------------------------------|--|
| Handle | - Light weight with easy grip and smooth rolling of Knob. |
| Locking Feature | - Unidirectional movement locking system to facilitate secure crushing / retrieval Of big C.B.D. Stone. |
| S.S. Sheath & Tip | - Inner cutting edges to perform lithotripsy .Outer tip rounded atraumatic. Outer S.S.sheath offering no strain on Duodenoscope elevation channel. |
| S.S. Sheath Locking to Handle | - Secure and firm fitting of S.S. Sheath with handle |
| PTFE Sheath | - Covers Basket and enters in to the Duct through Instrument channel with low Friction, Easy glide from outer s.s sheath. |

Technical Information

- Working length- 210 cm.
- Compatible with instrument Channel- 4.2 mm.
- Basket shape-Hexagonal
- Flush port for contrast.
- Atraumatic bullet type basket tip for ease of insertion and procedure.

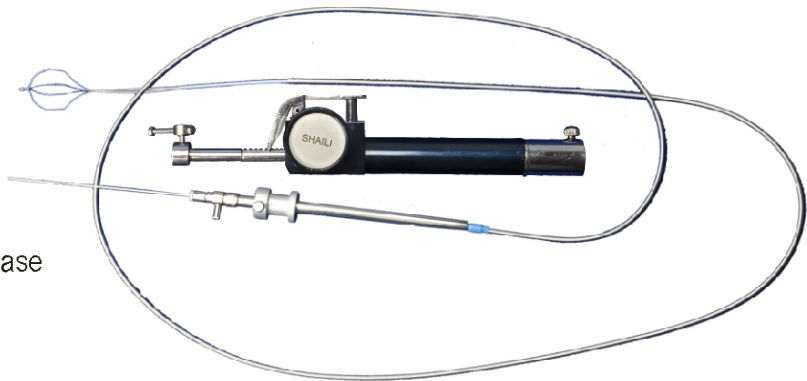

- Advantage : No need to remove endoscope for lithotripsy, can be done through the Scope- under vision C.B.D.Stone lithotripsy-Retrieval procedure.
- Availability : Endolithotripter sheath & Basket Supplied sterile, single use only. Handle supplied non sterile and reusable.

Ordering Information- - Mention product code x quantity required

Reference	Product Name	Sheath Ø	Basket Ø	Working Length
SEL-SHEATH	Endolithotripter Flexible Sheath With Basket Filament & Assembly	3.7 mm.	35 mm.	210 cm
SEL - B - 35	Endolithotripter Basket Only		35 mm.	210 cm
SEL - B - 40	Endolithotripter Basket Only		40 mm.	210 cm
SEL- H	Endolithotripter Handle Only			
SLITH-HRB-35	Endolithotripter Basket with PTFE tube		35 mm.	210 cm
SLITH-HRB-40	Endolithotripter Basket with PTFE tube		40 mm.	210 cm

Neg guide wire

Used to gain access through difficult biliary and pancreatic strictures to facilitate exchange of compatible wire guided accessories to the desired biliary or pancreatic ducts.

Technical Information

Size Diameter - 0.025 inch / 0.032 inch / 0.035 inch. / 0.038 inch.

Availability- Individually packed. Sterile For single use only.

Length - 260 cm, 450 cm, 525 cm. besides these are subject to confirmation with manufacturer.

Tip - Straight / Angle / J

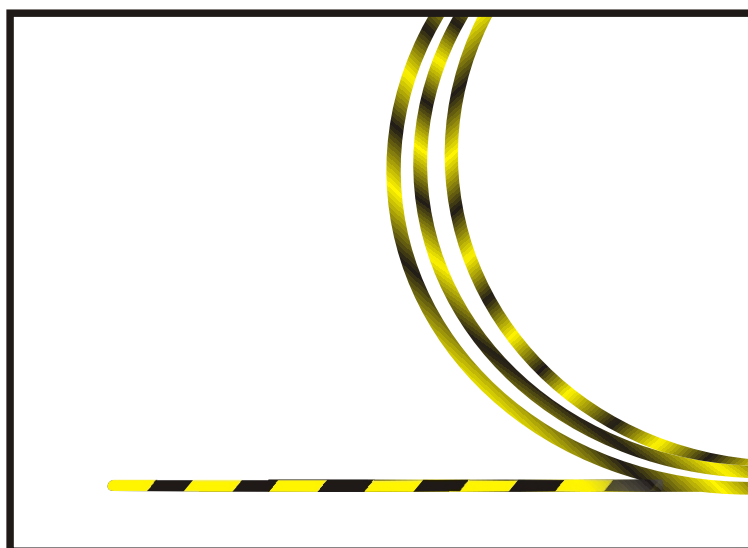

Ordering Information : Mention the product code x quantity required.

Reference	Product Name	Reference	Product Name
S-NEG-025-S X LENGTH	Neg Guide Wire 0.025 Straight	S-NEG-DBE-025-S-525	Neg Guide Wire 0.025 Straight For Double Balloon Enteroscope
S-NEG-025-A X LENGTH	Neg Guide Wire 0.025 Angulated	S-NEG-DBE-025-A-525	Neg Guide Wire 0.025 Angulated For Double Balloon Enteroscope
S-NEG-025-J X LENGTH	Neg Guide Wire 0.025 J Tip	S-NEG-DBE-025-J-525	Neg Guide Wire 0.025 J Tip For Double Balloon Enteroscope
S-NEG-032-S X LENGTH	Neg Guide Wire 0.032 Straight	S-NEG-DBE-032-S-525	Neg Guide Wire 0.032 Straight For Double Balloon Enteroscope
S-NEG-032-A X LENGTH	Neg Guide Wire 0.032 Angulated	S-NEG-DBE-032-A-525	Neg Guide Wire 0.032 Angulated For Double Balloon Enteroscope
S-NEG-032-J X LENGTH	Neg Guide Wire 0.032 J Tip	S-NEG-DBE-032-J-525	Neg Guide Wire 0.032 J Tip For Double Balloon Enteroscope
S-NEG-035-S X LENGTH	Neg Guide Wire 0.035 Straight	S-NEG-DBE-035-S-525	Neg Guide Wire 0.035 Straight For Double Balloon Enteroscope
S-NEG-035-A X LENGTH	Neg Guide Wire 0.035 Angulated	S-NEG-DBE-035-A-525	Neg Guide Wire 0.035 Angulated For Double Balloon Enteroscope
S-NEG-035-J X LENGTH	Neg Guide Wire 0.035 J Tip	S-NEG-DBE-035-J-525	Neg Guide Wire 0.035 J Tip For Double Balloon Enteroscope
S-NEG-038-S X LENGTH	Neg Guide Wire 0.038 Straight	S-NEG-DBE-038-S-525	Neg Guide Wire 0.038 Straight For Double Balloon Enteroscope
S-NEG-038-A X LENGTH	Neg Guide Wire 0.038 Angulated	S-NEG-DBE-038-A-525	Neg Guide Wire 0.038 Angulated For Double Balloon Enteroscope
S-NEG-038-J X LENGTH	Neg Guide Wire 0.038 J Tip	S-NEG-DBE-038-J-525	Neg Guide Wire 0.038 J Tip For Double Balloon Enteroscope

Tailormade device can be produced provided by pre approved drawing/ specification

Hydra neg guide wire

Used to gain access through difficult biliary and pancreatic strictures .
To facilitate exchange of compatible wire guided accessories to the
desired biliary or pancreatic ducts.

Technical Information :

Size Diameter - 0.025 inch. / 0.032 inch / 0.035 inch/0.038 inch

Length - 260 cm / 450 cm

Tip - Straight / Angle / J, with Extra Filifom Wire

Availability- Individually packed. Sterile For single use only.

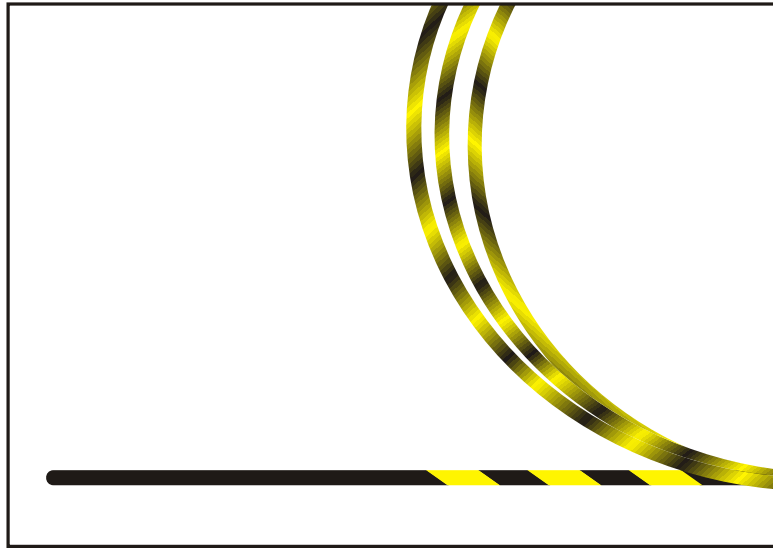

Ordering Information : Mention the product code x quantity required.

Reference	Product Name	Wire Ø
S-HYNEG-025-S X LENGTH	HYDRA NEG GUIDE WIRE	0.025 STRAIGHT
S-HYNEG-025-A X LENGTH	HYDRA NEG GUIDE WIRE	0.025 ANGULATED
S-HYNEG-025-J X LENGTH	HYDRA NEG GUIDE WIRE	0.025 J TIP
S-HYNEG-032-S X LENGTH	HYDRA NEG GUIDE WIRE	0.032 STRAIGHT
S-HYNEG-032-A X LENGTH	HYDRA NEG GUIDE WIRE	0.032 ANGULATED
S-HYNEG-032-J X LENGTH	HYDRA NEG GUIDE WIRE	0.032 J TIP
S-HYNEG-035-S X LENGTH	HYDRA NEG GUIDE WIRE	0.035 STRAIGHT
S-HYNEG-035-A X LENGTH	HYDRA NEG GUIDE WIRE	0.035 ANGULATED
S-HYNEG-035-J X LENGTH	HYDRA NEG GUIDE WIRE	0.035 J TIP
S-HYNEG-038-S X LENGTH	HYDRA NEG GUIDE WIRE	0.038 STRAIGHT
S-HYNEG-038-A X LENGTH	HYDRA NEG GUIDE WIRE	0.038 ANGULATED
S-HYNEG-038-J X LENGTH	HYDRA NEG GUIDE WIRE	0.038 J TIP

Tailormade device can be produced provided by pre approved drawing/ specification

Nitinol black wire

Used to gain access endoscopically through the difficult strictures.

Technical Information

Size Diameter - 0.025 inch / 0.032 inch / 0.035 inch. / 0.038 inch.

Availability- Individually packed. Sterile For single use only.

Length - 260 cm

Tip - Straight / Angle / J

Hydrophilic Coated

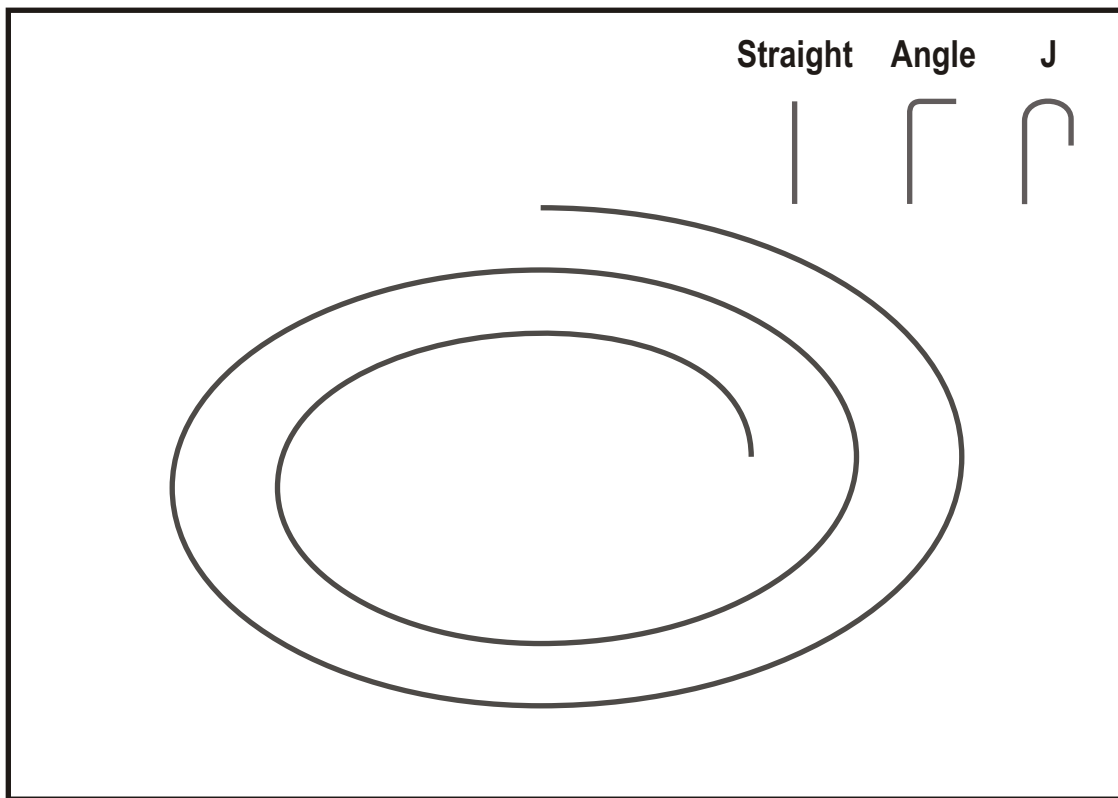

Ordering Information : Mention the product code x quantity required.

Reference	Product Name	Reference	Product Name
S-NBW-025-S X LENGTH	Nitinol Black Wire 0.025 Straight	S-NBW-035-S X LENGTH	Nitinol Black Wire 0.035 Straight
S-NBW-025-A X LENGTH	Nitinol Black Wire 0.025 Angulated	S-NBW-035-A X LENGTH	Nitinol Black Wire 0.035 Angulated
S-NBW-025-J X LENGTH	Nitinol Black Wire 0.025 J Tip	S-NBW-035-J X LENGTH	Nitinol Black Wire 0.035 J Tip
S-NBW-032-S X LENGTH	Nitinol Black Wire 0.032 Straight	S-NBW-038-S X LENGTH	Nitinol Black Wire 0.038 Straight
S-NBW-032-A X LENGTH	Nitinol Black Wire 0.032 Angulated	S-NBW-038-A X LENGTH	Nitinol Black Wire 0.038 Angulated
S-NBW-032-J X LENGTH	Nitinol Black Wire 0.032 J Tip	S-NBW-038-J X LENGTH	Nitinol Black Wire 0.038 J Tip

Stiff guide wire

Used to gain access endoscopically /
percutaneous through the difficult strictures.

Technical Information

Size Diameter - 0.035 inch.

Availability- Individually packed. Sterile For single use only.

Length - 110 cm, & 260 cm

Tip - Straight

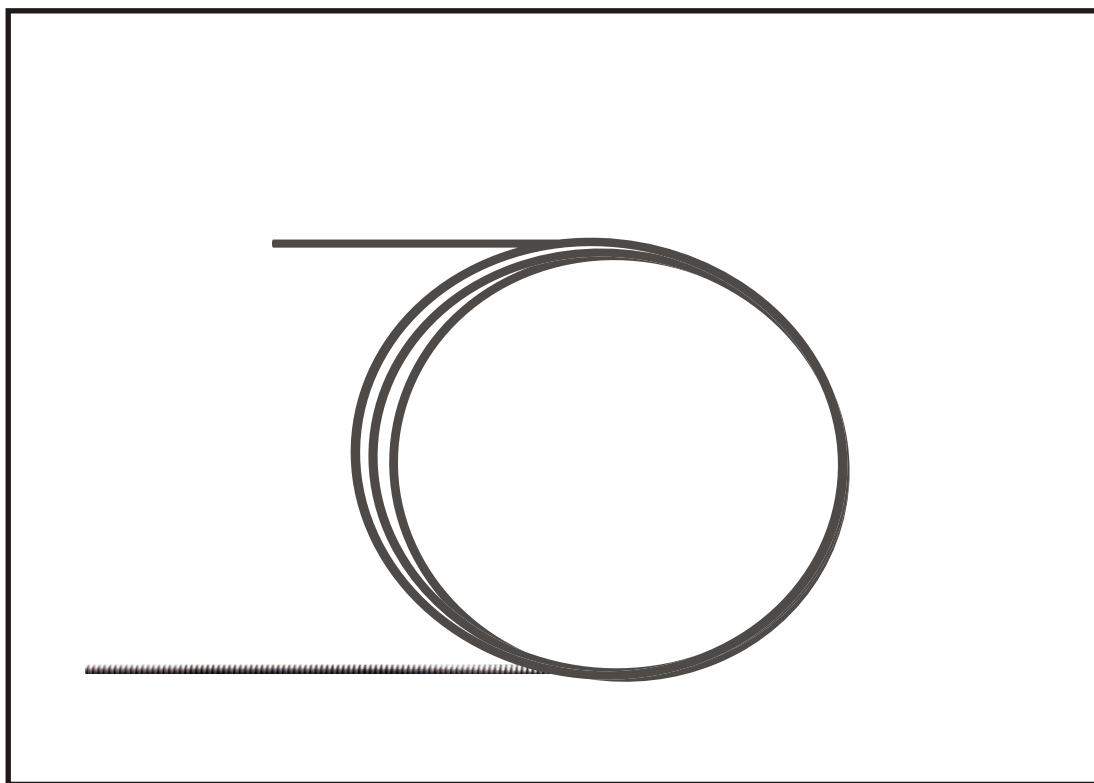

Ordering Information : Mention the product code x quantity required.

Reference	Product Name
S-SGW-035-S-110	Stiff Guide Wire 0.035 Straight
S-SGW-035-S-260	Stiff Guide Wire 0.035 Straight

Tailormade device can be produced provided by pre approved drawing/ specification

Hyneg combo guide wire

Used to gain access through difficult biliary and pancreatic strictures .
To facilitate exchange of compatible wire guided accessories to the
desired biliary or pancreatic ducts.

Technical Information

Size Diameter - 0.032 inch / 0.035 inch.

Availability- Individually packed. Sterile For single use only.

One end with black hydrophilic tip / other end with exchange wire tip.

Length - 260 cm & 450 cm

Tip - Straight

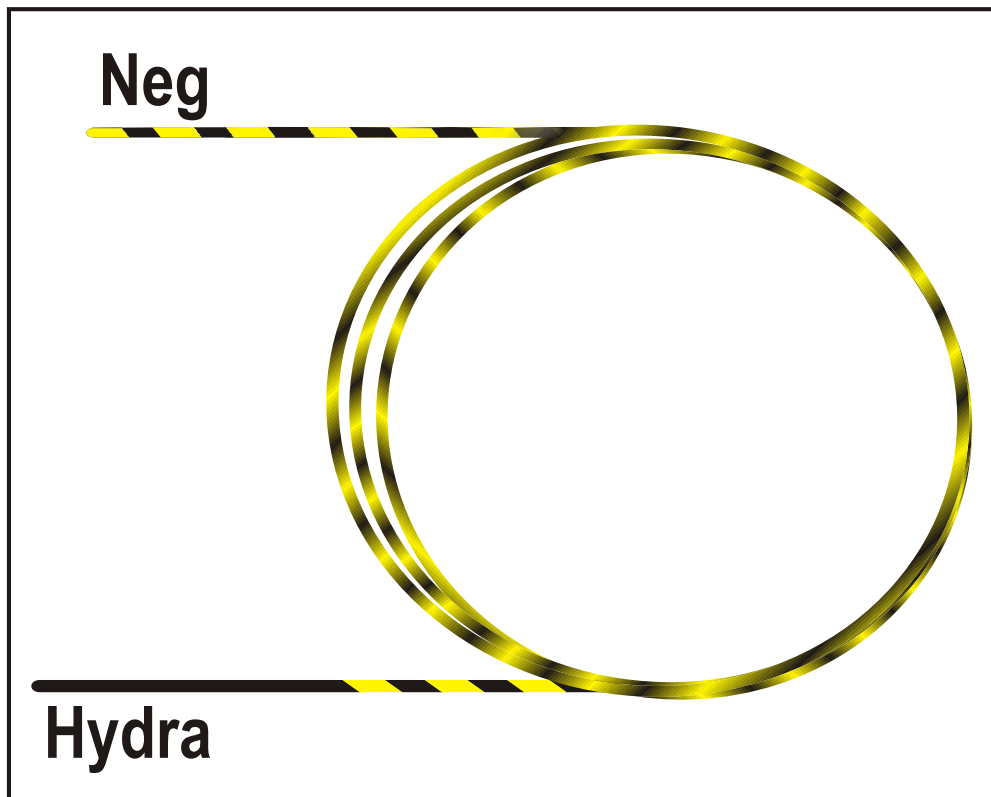

Ordering Information : Mention the product code x quantity required.

Reference	Product Name	Reference	Product Name
S-HYCG-032-S-260	Hyneg Combo Guide Wire 0.032 straight	S-HYCG-035-S-260	Hyneg Combo Guide Wire 0.035 straight
S-HYCG-032-S-450	Hyneg Combo Guide Wire 0.032 straight	S-HYCG-035-S-450	Hyneg Combo Guide Wire 0.035 straight

Super Stiff Hydra Neg Guide Wire

Used to gain access through difficult biliary and pancreatic strictures .
To facilitate exchange of compatible wire guided accessories to the
desired biliary or pancreatic ducts.

Technical Information :

Size Diameter - 0.025 inch./0.032 inch./0.035 inch. / 0.038 inch.

Length - 450 cm.

Tip - Straight, J, Angle

Availability- Individually packed. Sterile For single use only.

Stiffness of 0.035 with 0.025 size.

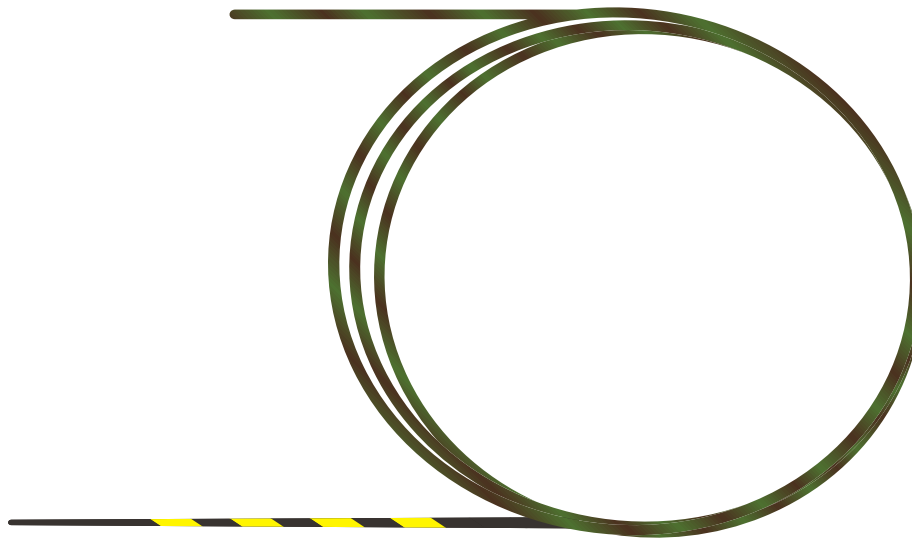

Ordering Information : Mention the product code x quantity required.

Reference	Product Name	Wire Ø	Tip
S-SSHYNEG-025-S - 450	SUPER STIFF HYDRA NEG GUIDE WIRE	0.025 "	STRAIGHT
S-SSHYNEG-032-S - 450	SUPER STIFF HYDRA NEG GUIDE WIRE	0.032"	STRAIGHT
S-SSHYNEG-035-S - 450	SUPER STIFF HYDRA NEG GUIDE WIRE	0.035"	STRAIGHT
S-SSHYNEG-038-S - 450	SUPER STIFF HYDRA NEG GUIDE WIRE	0.038"	STRAIGHT
S-SSHYNEG-025-A - 450	SUPER STIFF HYDRA NEG GUIDE WIRE	0.025 "	ANGLE
S-SSHYNEG-032-A - 450	SUPER STIFF HYDRA NEG GUIDE WIRE	0.032"	ANGLE
S-SSHYNEG-035-A - 450	SUPER STIFF HYDRA NEG GUIDE WIRE	0.035"	ANGLE
S-SSHYNEG-038-A - 450	SUPER STIFF HYDRA NEG GUIDE WIRE	0.038"	ANGLE
S-SSHYNEG-025-J - 450	SUPER STIFF HYDRA NEG GUIDE WIRE	0.025 "	J Tip
S-SSHYNEG-032-J - 450	SUPER STIFF HYDRA NEG GUIDE WIRE	0.032"	J Tip
S-SSHYNEG-035-J - 450	SUPER STIFF HYDRA NEG GUIDE WIRE	0.035"	J Tip
S-SSHYNEG-038-J - 450	SUPER STIFF HYDRA NEG GUIDE WIRE	0.038"	J Tip

Stone Extraction Balloon

Used For Endoscopic Extraction Of Biliary Stones .

Technical Information

Technical Information-

Triple lumen feature provides wire guide access to facilitate stone extraction, from desired location during procedure.

Catheter Diameter - 7 Fr .

Compatible with 0.035 inch wire guide.

Availability - Individually packed. Sterile for single use only.

Working length - 200 cm.

Balloon diameter - 16 mm.

Balloon length - 16 mm.

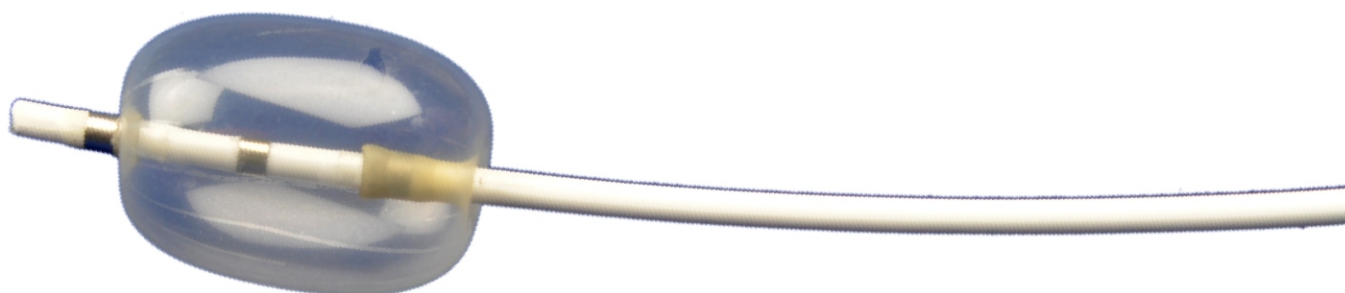

Reference	Catheter Diameter FR	Functional Catheter Length	Diameter of Inflated Balloon	Balloon Max Air Inflation	Balloon Max Fluid Injection	Recommended Guiding Wire (Inch)	Syringe CC	Tip Diameter FR
SSEC - 7	7	200 cm	16 mm	3.5 cc	3.0 ml	0.035"	5	7

Achalasia Balloon Dilator

Intended for dilation of the lower esophageal sphincter in patient with achalasia.

Technical Information :

Inflated Balloon Diameter - 25mm, 30mm, 35 mm

Balloon length : 80 mm.

Shaft Diameter : 5mm.

Working Length : 90 cm.

Wire Guide Compatibility : 0.038"

Burst pressure : 3 ATM

High Radial Vector Force.

Atraumatic Tip.

Radioopaque marker inside the balloon.

Sterile for Single use only.



Ordering Information - Mention product code x quantity required

Reference	Product Name	Balloon Ø
SABD - 25	Achalasia Balloon Dilator	25 mm
SABD - 30	Achalasia Balloon Dilator	30 mm
SABD - 35	Achalasia Balloon Dilator	35 mm

Esophageal Balloon Dilator

Used to dilate esophageal strictures over previously placed wire guide through the scope

Technical Information :

- Inflated balloon diameter - 6mm, 8mm, 10 mm, 12 mm, 14 mm, 16mm, 18mm
- Shaft diameter : 2.5 mm
- Working length : 1800 mm
- Wire guide compatibility 0.035"
- Sterile for single use only.



Ordering Information- Mention the product code x quantity required.

Reference	Product Name	Balloon Length	Inflated Balloon Ø	Burst Pressure
S-EBD - 640	Esophageal Balloon Dilator	40 mm	6 mm	10 ATM
S-EBD - 840	Esophageal Balloon Dilator	40 mm	8 mm	10 ATM
S-EBD - 1040	Esophageal Balloon Dilator	40 mm	10 mm	10 ATM
S-EBD - 1260	Esophageal Balloon Dilator	60 mm	12 mm	6 ATM
S-EBD - 1460	Esophageal Balloon Dilator	60 mm	14 mm	6 ATM
S-EBD - 1680	Esophageal Balloon Dilator	80 mm	16 mm	6 ATM
S-EBD - 1880	Esophageal Balloon Dilator	80 mm	18 mm	5 ATM

Biliary Balloon Dilator

Used to dilate papilla or biliary strictures through the scope

Technical Information :

Inflated balloon diameter - 6mm, 8mm, 10 mm

Balloon length : 4 cm

Shaft diameter : 2.5 mm

Working length : 2000 mm

Wire guide compatibility : 0.035"

Atraumatic Tip.

Sterile for single use only.

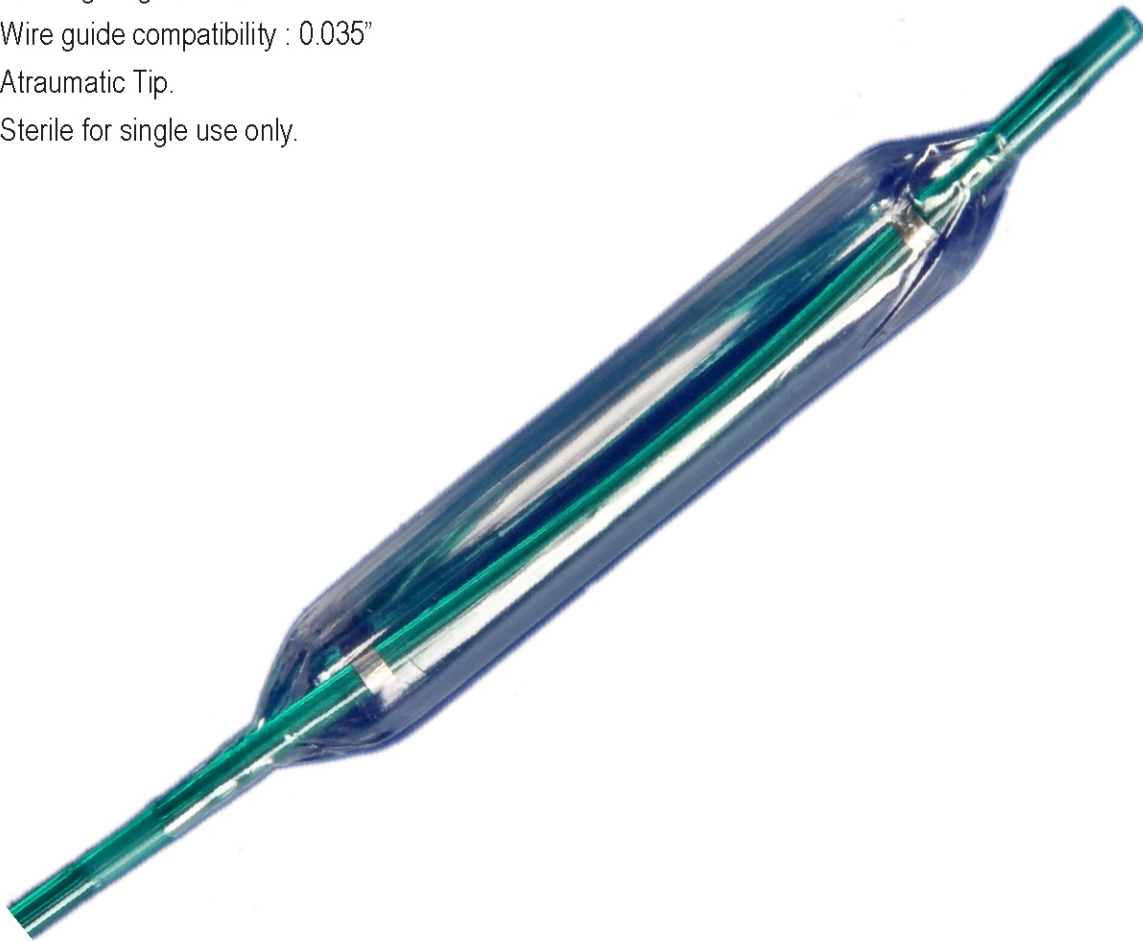

Ordering Information- - Mention product code x quantity required

Reference	Product Name	Balloon Ø	Burst Pressure
S-BBD -640	Biliary Balloon Dilator	6 mm	10ATM
S-BBD - 840	Biliary Balloon Dilator	8 mm	10ATM
S-BBD - 1040	Biliary Balloon Dilator	10 mm	10ATM

3 Stage Balloon Dilator

Used to dilate strictures of the Gastrointestinal tract including strictures of the Esophagus / Colonic / Biliary through the scope

Precise sizing control with confidence during dilatation

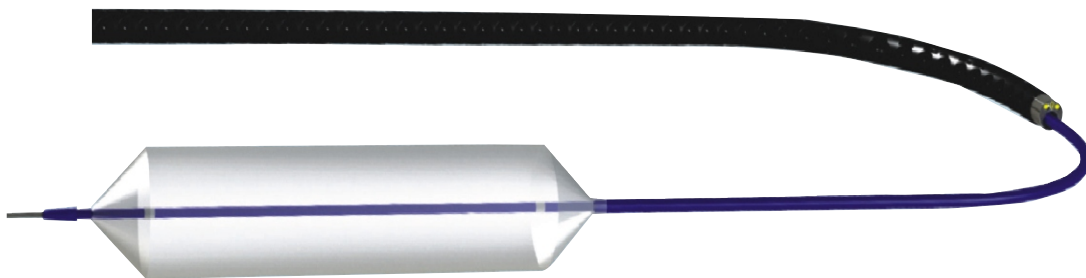

Designed to provide 3 stage gradual dilatation of strictures
Versatile G.I. tract treatment with accurate sizing therapy

Provide greater balloon surface area during dilation
2 radioopaque marker to facilitate accurate balloon positioning

Ordering Information- Mention the product code x quantity required.

Reference	Product Name	Guidewire Size	Working Length	Inflated Balloon Diameter	Balloon Length	Inflation Pressure	Compatible Channel \varnothing
S-3BD-101112	3 Stage Esophageal Balloon	0.035"	180cm	10-11-12mm	55mm	3-5-8atm	2.8mm
S-3BD-121315	3 Stage Esophageal Balloon	0.035"	180cm	12-13.5-15mm	55mm	3-4.5-8atm	2.8mm
S-3BD-151618	3 Stage Esophageal Balloon	0.035"	180cm	15-16.5-18mm	55mm	3-4.5-7atm	2.8/3.2mm*
S-3BD-181920	3 Stage Esophageal Balloon	0.035"	180cm	18-19-20mm	55mm	3-4.5-6atm	2.8/3.2mm*
S-3BD-101112C	3 Stage Esophageal Balloon	0.035"	240cm	10-11-12mm	55mm	3-5-8atm	2.8mm
S-3BD-121315C	3 Stage Esophageal Balloon	0.035"	240cm	12-13.5-15mm	55mm	3-4.5-8atm	2.8mm
S-3BD-151618C	3 Stage Esophageal Balloon	0.035"	240cm	15-16.5-18mm	55mm	3-4.5-7atm	2.8/3.2mm*
S-3BD-181920C	3 Stage Esophageal Balloon	0.035"	240cm	18-19-20mm	55mm	3-4.5-6atm	2.8/3.2mm*

* Requires a 2.8mm Olympus Brand Endoscope channel or a 3.2mm Pentax or Fujinon Brand Endoscope channel**

Biliary Stent

Used to drain bile from obstructed biliary duct.

Technical Information

Diameter 5 Fr. - 7Fr. - 8.5 Fr. - 10 Fr. & 11.5 Fr. Size

Length 3 cm. to 20 cm. as per customer requirement.

Material choice- Radioopaque PTFE OR PE.

Variants

- Straight - S
- Double Pigtail - DP
- Amsterdam - AMST
- Standard - STD
- Pancreatic - PAN
- S Banded - SB
- Single Pigtail - SP
- C Shape - CS
- Tree Type (Pine tree) - T

Available - Sterile, Single use.

Wireguide Compatibility - 0.035".

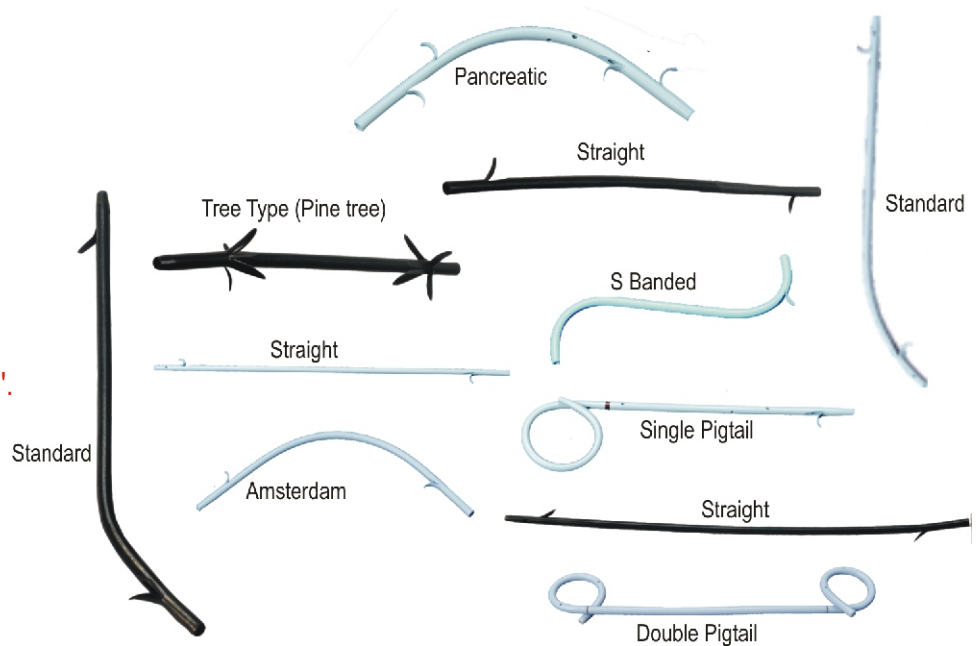

Ordering Information- Mention the product code x required Length x QTY required.

Example : Biliary Stent X Plastic X 7fr X Standard X10cm length = SBS-PU-7-STD-10

Specifications	Stent 5 Fr. Reference	Biliary Stent 7 Fr. Reference	Biliary Stent 8.5 Fr. Reference	Biliary stent 10Fr. Reference	Biliary stent 11.5 Fr. Reference
Material					
PTFE	SBS-TEF-5	SBS-TEF-7	SBS-TEF-8.5	SBS-TEF-10	SBS-TEF-11.5
PE	SBS-PU-5	SBS-PU-7	SBS-PU-8.5	SBS-PU-10	SBS-PU-11.5
Variants :					
1- Straight	SBS-TEF-5-S SBS-PU-5-S	SBS-TEF-7-S SBS-PU-7-S	SBS-TEF-8.5-S SBS-PU-8.5-S	SBS-TEF-10-S SBS-PU-10-S	SBS-TEF-11.5-S SBS-PU-11.5-S
2-Double Pig Tail	SBS-PU-5-DP	SBS-PU-7-DP	SBS-PU-8.5-DP	SBS-PU-10-DP	SBS-PU-11.5-DP
3-Standard	SBS-TEF-5-STD SBS-PU-5-STD	SBS-TEF-7-STD SBS-PU-7-STD	SBS-TEF-8.5-STD SBS-PU-8.5-STD	SBS-TEF-10-STD SBS-PU-10-STD	SBS-TEF-11.5-STD SBS-PU-11.5-STD
4-Amsterdam	SBS-TEF-5-AMST SBS-PU-5-AMST	SBS-TEF-7-AMST SBS-PU-7-AMST	SBS-TEF-8.5-AMST SBS-PU-8.5-AMST	SBS-TEF-10-AMST SBS-PU-10-AMST	SBS-TEF-11.5-AMST SBS-PU-11.5-AMST
5- Pancreatic	SBS-TEF-5-PAN SBS-PU-5-PAN	SBS-TEF-7-PAN SBS-PU-7-PAN	SBS-TEF-8.5-PAN SBS-PU-8.5-PAN	SBS-TEF-10-PAN SBS-PU-10-PAN	SBS-TEF-11.5-PAN SBS-PU-11.5-PAN
6- S Banded	SBS-PU-5-SB	SBS-PU-7-SB	SBS-PU-8.5-SB	SBS-PU-10-SB	SBS-PU-11.5-SB
7- Single Pigtail	SBS-PU-5-SP	SBS-PU-7-SP	SBS-PU-8.5-SP	SBS-PU-10-SP	SBS-PU-11.5-SP
8- C Shape	SBS-PU-5-CS SBS-TEF-5-CS	SBS-PU-7-CS SBS-TEF-7-CS	SBS-PU-8.5-CS SBS-TEF-8.5-T	SBS-PU-10-CS SBS-TEF-10-CS	SBS-PU-11.5-CS SBS-TEF-11.5-T
9- Tree Type					

Biliary Stent Set

Used to drain bile from obstructed biliary duct.

Technical Information

Biliary Stent Set Contain - Biliary Stent & Pusher of 5 Fr. & 7Fr.

Biliary Stent Set 8.5 Fr. - 10 Fr. & 11.5 Fr. Contains - Biliary Stent, Pusher & Guiding Catheter

Length of Guiding Catheter 220 cm / 320 cm

Available - Sterile, Single use.

Wireguide Compatibility - 0.035".

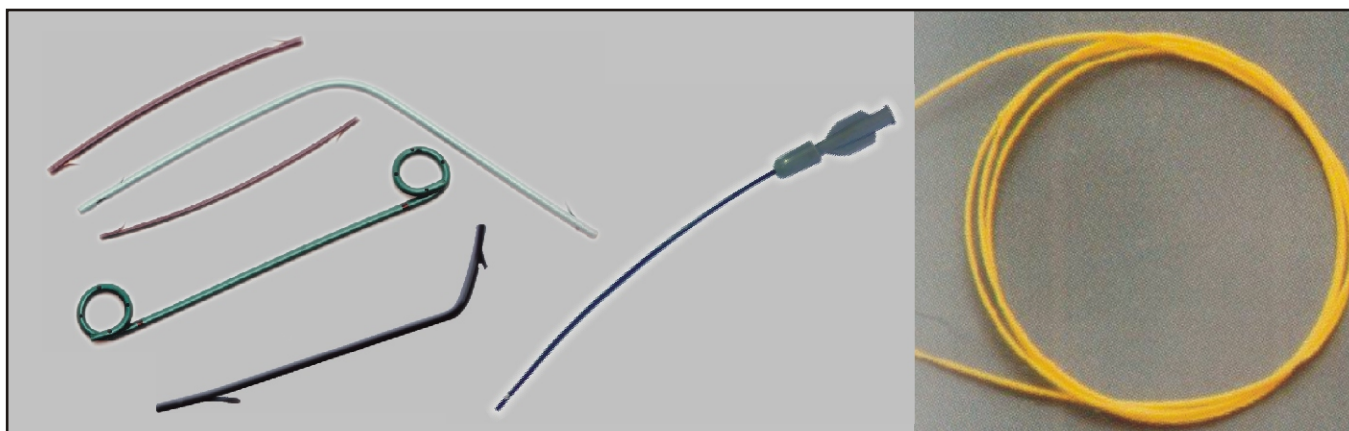

Ordering Information- Mention the product code x required Length x QTY required.

Example : Biliary Stent set X Plastic X 10 fr X Double Pigtail X 10cm long = SBSS-PU-10-DP-10

Specifications	Stent 5 Fr. Reference	Biliary Stent 7 Fr. Reference	Biliary Stent 8.5 Fr. Reference	Biliary stent 10Fr. Reference	Biliary stent 11.5 Fr. Reference
Material					
PTFE	SBSS-TEF-5	SBSS-TEF-7	SBSS-TEF-8.5	SBSS-TEF-10	SBSS-TEF-11.5
PE	SBSS-PU-5	SBSS-PU-7	SBSS-PU-8.5	SBSS-PU-10	SBSS-PU-11.5
Variant :					
1- Straight	SBSS-TEF-5-S SBSS-PU-5-S	SBSS-TEF-7- S SBSS-PU-7-S	SBSS-TEF-8.5-S SBSS-PU-8.5-S	SBSS-TEF-10-S SBSS-PU-10-S	SBSS-TEF-11.5-S SBSS-PU-11.5-S
2-Double Pig Tail	SBSS-PU-5-DP	SBSS-PU-7 -DP	SBSS-PU-8.5-DP	SBSS-PU-10 -DP	SBSS-PU-11.5 - DP
3-Standard	SBSS-TEF-5-STD SBSS-PU-5-STD	SBSS-TEF-7-STD SBSS-PU-7-STD	SBSS-TEF-8.5-STD SBSS-PU-8.5-STD	SBSS-TEF-10 -STD SBSS-PU-10 -STD	SBSS-TEF-11.5-STD SBSS-TEF-11.5-STD
4-Amsterdam	SBSS-TEF-5-AMST SBSS-PU-5-AMST	SBSS-TEF-7 -AMST SBSS-PU-7 -AMST	SBSS-TEF-8.5-AMST SBSS-PU-8.5-AMST	SBSS-TEF-10 -AMST SBSS-PU-10 -AMST	SBSS-TEF-11.5-AMST SBSS-PU-11.5-AMST
5- Pancreatic	SBSS-TEF-5-PAN SBSS-PU-5-PAN	SBSS-TEF-7-PAN SBSS-PU-7-PAN	SBSS-TEF-8.5-PAN SBSS-PU-8.5-PAN	SBSS-TEF-10-PAN SBSS-PU-10-PAN	SBSS-TEF-11.5-PAN SBSS-PU-11.5-PAN
6- S Banded	SBSS-PU-5-SB	SBSS-PU-7 - SB	SBSS-PU-8.5-SB	SBSS-PU-10 -SB	SBSS-PU-11.5-PAN
7- Single Pigtail	SBSS-PU-5-SP	SBSS-PU-7 - SP	SBSS-PU-8.5-SP	SBSS-PU-10 -SP	SBSS-PU-11.5 - SP
8- C Shape	SBSS-PU-5-CS SBSS-TEF-5-CS	SBSS-PU-7 - CS SBSS -TEF-7- CS	SBSS-PU-8.5-CS SBSS-TEF-8.5-CS	SBSS-PU-10 -CS SBSS-TEF-10-CS	SBSS-PU-11.5 - CS SBSS-TEF-11.5-CS
9- Tree Type			SBSS-TEF-8.5-T	SBSS-TEF-10-T	SBSS-TEF-11.5-T

Single Action Stent Introducer System

Used For Endoscopically Biliary Stent Placement to Reduce time and Easier Stent Placement.

Technical Information

Size - 8.5fr., 10fr. & 11.5fr. Single action stent deployment.

Radioopaque Marker Over Guiding Catheter.

Low Friction Movement.

Compatible With 0.035 Inch Ø Wire Guide.

Supply Without Guide Wire and Stent .

Availability - Sterile, For Single Use Only.

Pusher length - 180cm

Guiding catheter length - 220cm

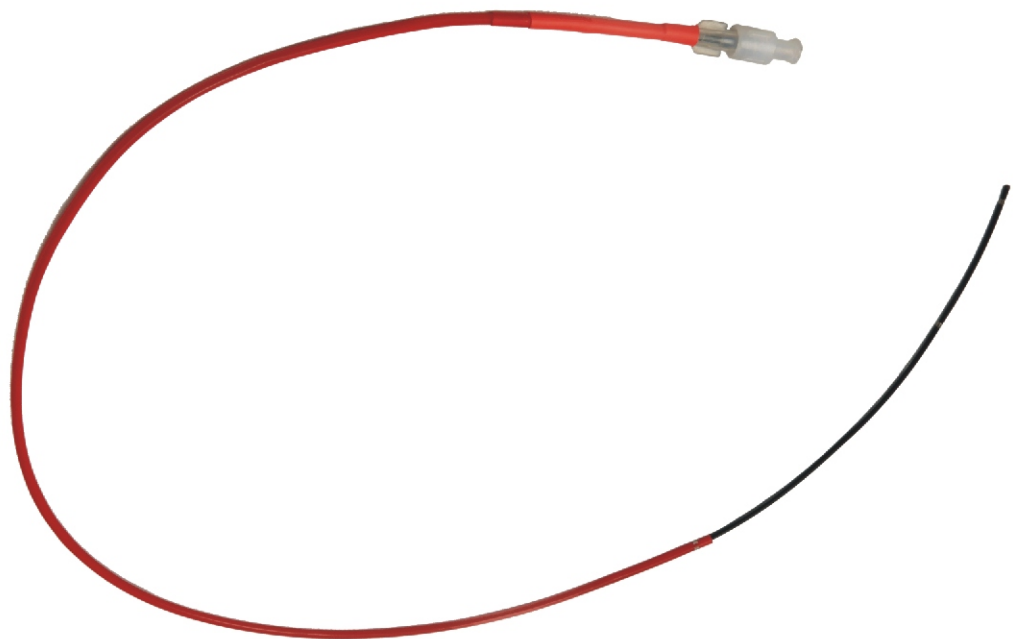

Ordering Information- - Mention product code x quantity required

Reference	Product Name	Size	Remark
SSIS - 8.5	Single Action Stent Introducer System	8.5 Fr.	Without Guide Wire and Stent.
SSIS - 10	Single Action Stent Introducer System	10 Fr.	Without Guide Wire and Stent.
SSIS - 11.5	Single Action Stent Introducer System	11.5 Fr.	Without Guide Wire and Stent.

Single Action Stent Introducer Set

Used For Endoscopically Biliary Stent Placement
to Reduce time and Easier Stent Placement.

Technical Information

Size - 8.5fr., 10fr. & 11.5fr. Single action stent deployment.

Radiopaque Marker Over Guiding Catheter.

Low Friction Movement.

Compatible With 0.035 Inch Ø Wire Guide.

Pusher length - 180cm

Guiding catheter length - 220cm

Supply with Biliary Stent .

Supply without Guide Wire.

Availability - Sterile, For Single Use Only.

Biliary Stent Length - 3 cm to 20 cm

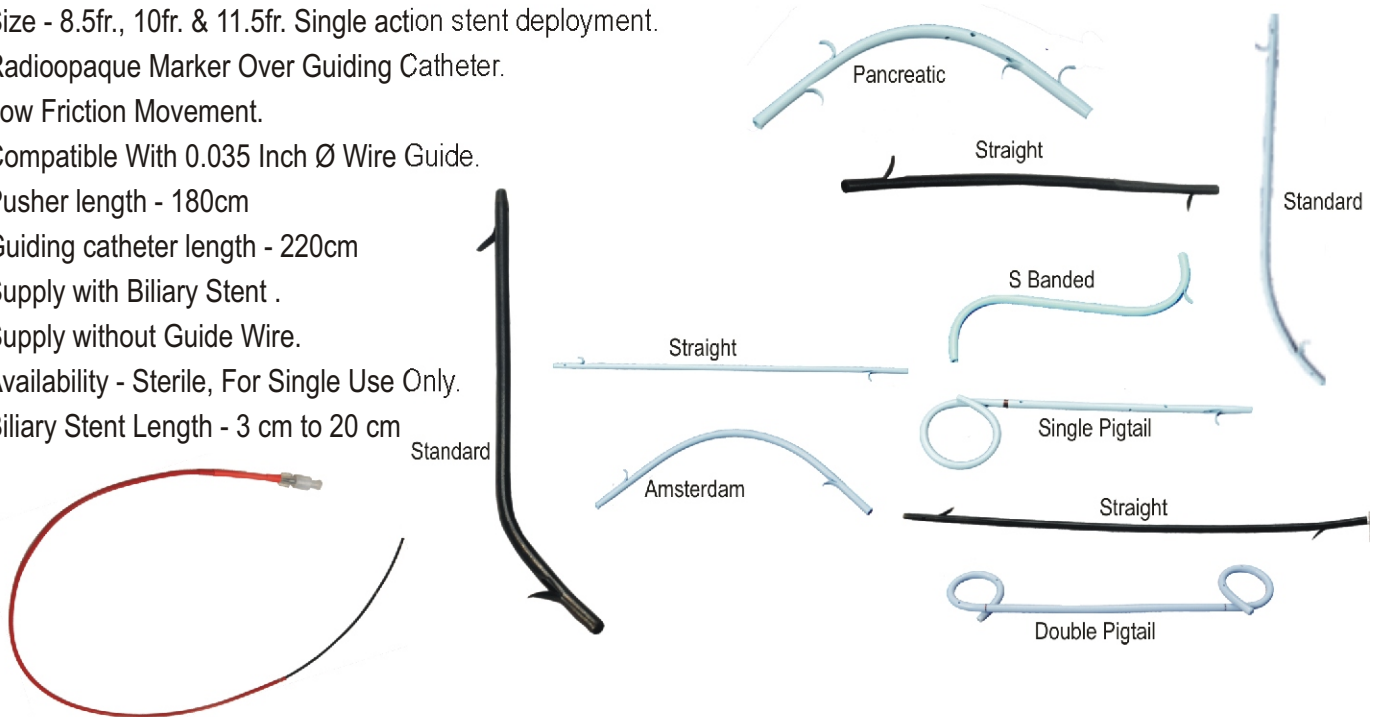

Ordering Information- Mention the product code x required Length x QTY required.

Example : single action stent introducer system set X 10 fr X Teflon X 10 fr x Straight X 10cm long = SSISS-10-TEF-10-S-10

Specifications	Single Action Stent Introducer Set 8.5 Fr.	Single Action Stent Introducer Set 10 Fr.	Single Action Stent Introducer Set 11.5 Fr.
Material			
PTFE	SSISS-8.5-TEF-8.5	SSISS-10-TEF-10	SSISS-11.5-TEF-11.5
PE	SSISS-8.5-PU-8.5	SSISS-10-PU-10	SSISS-11.5-PU-11.5
Variant :			
1- Straight	SSISS-8.5-TEF-8.5-S SSISS-8.5-PU-8.5-S	SSISS-10-TEF-10-S SSISS-10-PU-10-S	SSISS-11.5-TEF-11.5-S SSISS-11.5-PU-11.5-S
2-Double Pig Tail	SSISS-8.5-PU-8.5-DP	SSISS-10-PU-10 -DP	SSISS-11.5-PU-11.5 - DP
3-Standard	SSISS-8.5-TEF-8.5-STD SSISS-8.5-PU-8.5-STD	SSISS-10-TEF-10 -STD SSISS-10-PU-10 -STD	SSISS-11.5-TEF-11.5-STD SSISS-11.5-PU-11.5-STD
4-Amsterdam	SSISS-8.5-TEF-8.5-AMST SSISS-8.5-PU-8.5-AMST	SSISS-10-TEF-10 -AMST SSISS-10-PU-10 -AMST	SSISS-11.5-TEF-11.5-AMST SSISS-11.5-PU-11.5-AMST
5- Pancreatic	SSISS-8.5-TEF-8.5-PAN SSISS-8.5-PU-8.5-PAN	SSISS-10-TEF-10-PAN SSISS-10-PU-10-PAN	SSISS-11.5-TEF-11.5-PAN SSISS-11.5-PU-11.5-PAN
6- S Banded	SSISS-8.5-PU-8.5-SB	SSISS-10-PU-10 -SB	SSISS-11.5-PU-11.5 - SB
7- Single Pigtail	SSISS-8.5-PU-8.5-SP	SSISS-10-PU-10 -SP	SSISS-11.5-PU-11.5 - SP
8- C Shape	SSISS-8.5-PU-8.5-CS	SSISS-10-PU-10 -CS	SSISS-11.5-PU-11.5 - CS

Guiding Catheter

Used to place biliary stent endoscopically.

Technical Information

Size - 5 fr. - 6 fr. - 7 fr.

Working Length - 45 cm, 220 cm & 320 cm

Availability - Sterile - Single use only.

Individually packed.

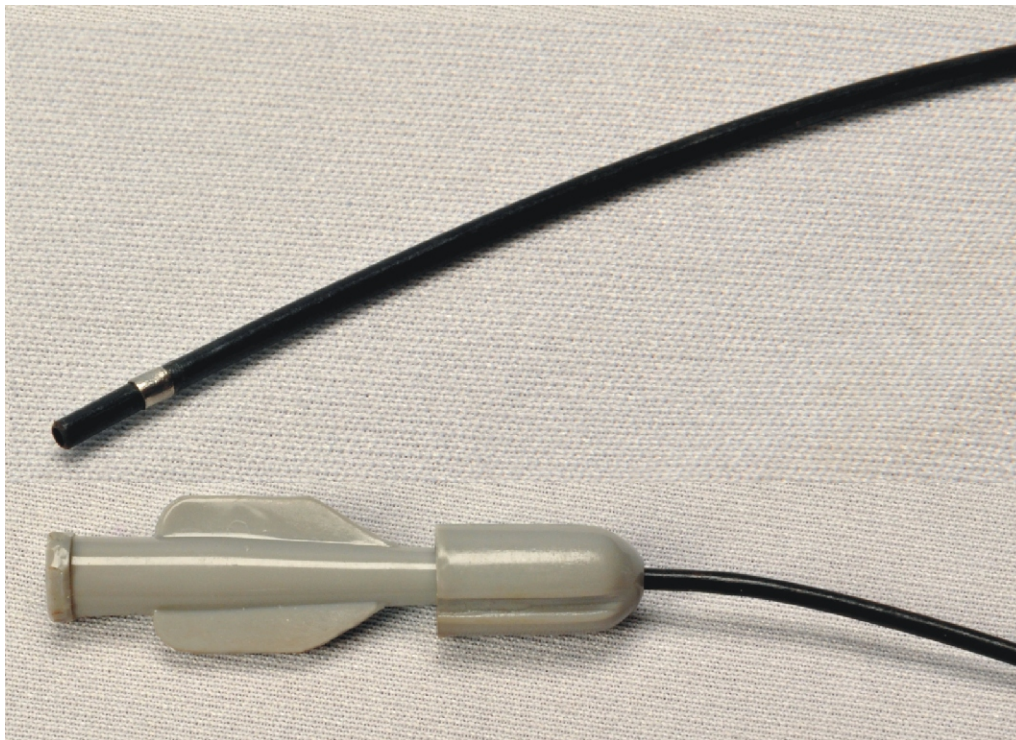

Ordering Information - Mention the product code x quantity required.

Reference	Product Name	Size	Working Length	Compatible Pusher
SGC-645	GUIDING CATHETER	6FR	45 CM	
SGC-5320	GUIDING CATHETER	5FR	320 CM	8.5 FR
SGC-5220	GUIDING CATHETER	5FR	220 CM	8.5 FR
SGC-6320	GUIDING CATHETER	6FR	320 CM	10 FR
SGC-6220	GUIDING CATHETER	6FR	220 CM	10 FR
SGC-7320	GUIDING CATHETER	7FR	320 CM	11.5 FR
SGC-7220	GUIDING CATHETER	7FR	220 CM	11.5 FR

Stent Pusher

Endoscopically biliary stent placement

Technical Information

Size - 5 fr. - 7 fr. - 8.5 fr. - 10fr. - 11.5fr.

Availability - Sterile - Single use only.

Individually packed.

Length as per customer requirement

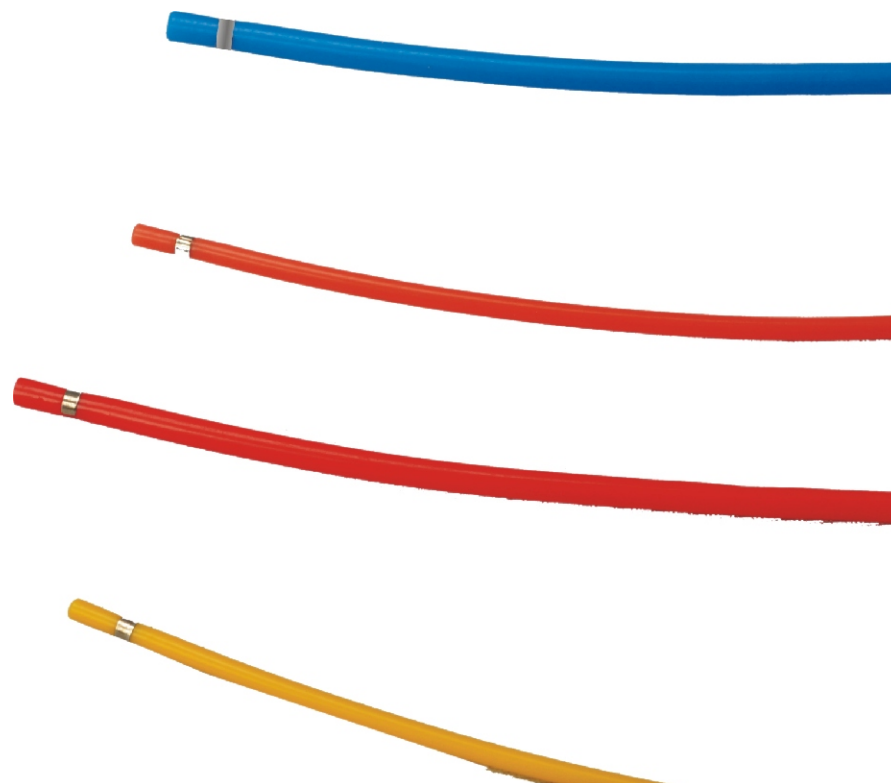

Ordering Information - Mention the product code x quantity required.

X Length as per customer requirement

Reference	Product Name	Size	Required Channel Ø
SSP-5 -X Length	Biliary Stent Pusher	5 Fr.	≥3.2 mm
SSP-7-X Length	Biliary Stent Pusher	7 Fr.	≥3.2 mm
SSP-8.5-X Length	Biliary Stent Pusher	8.5 Fr.	4.2 mm
SSP-10-X Length	Biliary Stent Pusher	10 Fr.	4.2 mm
SSP-11.5-X Length	Biliary Stent Pusher	11.5 Fr.	4.2 mm

Biliary Dilator

Used to dilate papilla or biliary strictures Through the Scope.

Technical Information

Tapering length - 3 cm.

Size - 5fr. - 6fr. - 7 fr.- 8.5 fr. - 9fr. - 10fr. - 11.5fr.

Radioopaque PTFE material .

Availability - Sterile - Single use only.

Individually packed.



Ordering Information - Mention the product code x quantity required.

Reference	Product Name	Tip Ø	Required Channel Ø	Working Length
S - BD- 5	Biliary Dilator 5 Fr.	2.5 Fr.	3.2 mm	200 cm.
S - BD- 6	Biliary Dilator 6 Fr.	3.5 Fr.	3.2 mm	200 cm.
S - BD- 7	Biliary Dilator 7 Fr.	4 Fr.	3.2 mm	200 cm.
S - BD- 8.5	Biliary Dilator 8.5 Fr.	5.5 Fr.	3.2 mm	200 cm.
S - BD- 9	Biliary Dilator 9 Fr.	6 Fr.	3.2 mm	200 cm.
S - BD- 10	Biliary Dilator 10 Fr.	6 Fr.	4.2 mm	200 cm.
S - BD- 11.5	Biliary Dilator 11.5 Fr.	8.5 Fr.	4.2 mm	200 cm.
S - BD- 5 - DBE	Biliary Dilator 5 Fr. For Double Balloon Enteroscope	2.5 Fr.	3.2 mm	280 cm.
S - BD- 6 - DBE	Biliary Dilator 6 Fr. For Double Balloon Enteroscope	3.5 Fr.	3.2 mm	280 cm.
S - BD- 7 - DBE	Biliary Dilator 7 Fr. For Double Balloon Enteroscope	4 Fr.	3.2 mm	280 cm.
S - BD- 8.5 - DBE	Biliary Dilator 8.5 Fr. For Double Balloon Enteroscope	5.5 Fr.	3.2 mm	280 cm.
S - BD- 9 - DBE	Biliary Dilator 9 Fr. For Double Balloon Enteroscope	6 Fr.	3.2 mm	280 cm.
S - BD- 10 - DBE	Biliary Dilator 10 Fr. For Double Balloon Enteroscope	6 Fr.	4.2 mm	280 cm.
S - BD- 11.5 - DBE	Biliary Dilator 11.5 Fr. For Double Balloon Enteroscope	8.5 Fr.	4.2 mm	280 cm.

ERCP Cannula

Used endoscopically to opacify the biliary duct with radioopaque contrast Material for fluoroscopic view.

Technical Information

Type - Tapered tip / Ball tip / Double lumen

Catheter tip Diameter - 4.5 Fr. / 5.5 Fr.

Recommended wire guide Diameter 0.035 inch.

Availability - Sterile For single use only.

Length- 200 cm & 280 cm

Individually packed.

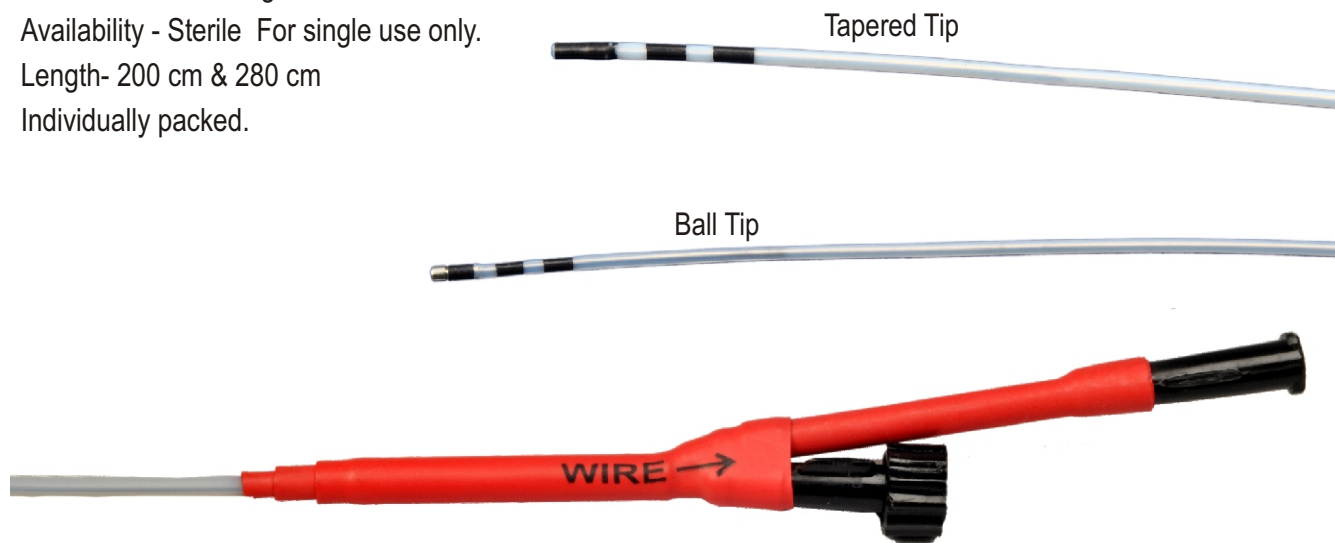

Ordering Information- Mention the product code x quantity required.

Reference	Product Name	Tip Ø	Working Length	Required Channel Ø
S- ERC-T-SL	Single Lumen ERCP Cannula Tapered Tip	4.5 Fr	200 cm	2.8 mm
S- ERC-B-SL	Single Lumen ERCP Cannula Ball Tip	5.5 Fr	200 cm	2.8 mm
S- ERC-T-DL	Double Lumen ERCP Cannula Tapered Tip	5.5 Fr	200 cm	2.8 mm
S- ERC-T-SL-DBE	Single Lumen ERCP Cannula Tapered Tip For Double Balloon Enteroscope	4.5 Fr	280 cm	2.8 mm
S- ERC-B-SL-DBE	Single Lumen ERCP Cannula Ball Tip For Double Balloon Enteroscope	5.5 Fr	280 cm	2.8 mm
S- ERC-T-DL-DBE	Double Lumen ERCP Cannula Tapered Tip For Double Balloon Enteroscope	5.5 Fr	280 cm	2.8 mm

Biliary Metal Stent

Used for Stenosis or Obstructed Biliary tract caused by benign or malignant changes.

Technical Information

With Introducer System.

Radiotherapy compatible.

Expanded Stent Diameter. - 10mm.

Stent Length - 60mm / 80mm / 100mm/120mm/150mm

Uncovered stent.

Compatible with 0.038 inch wire guide.

Compatible with instrument channel size - 3.2mm

Availability - Sterile - For single use only.

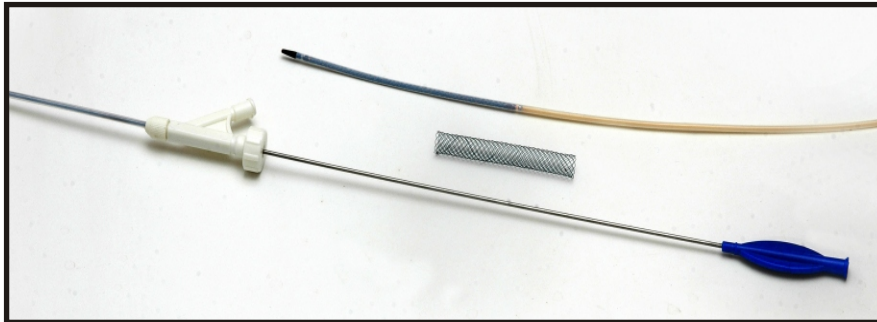

Ordering Information- Mention the product code x quantity required.

Reference	Product Name	Stent Length	Stent Ø
S - MBS - 6	Biliary Metal Stent	60mm.	10mm.
S - MBS - 8	Biliary Metal Stent	80mm.	10mm.
S - MBS - 10	Biliary Metal Stent	100mm.	10mm.
S - MBS - 12	Biliary Metal Stent	120mm.	10mm.
S - MBS - 15	Biliary Metal Stent	150mm.	10mm.

Pancreatic Basket

Removal of stone from pancreatic duct

Technical Information

Sheath Diameter - 5 Fr.
Availability- Individually packed. Sterile For single use only.
Length - 230 cm.

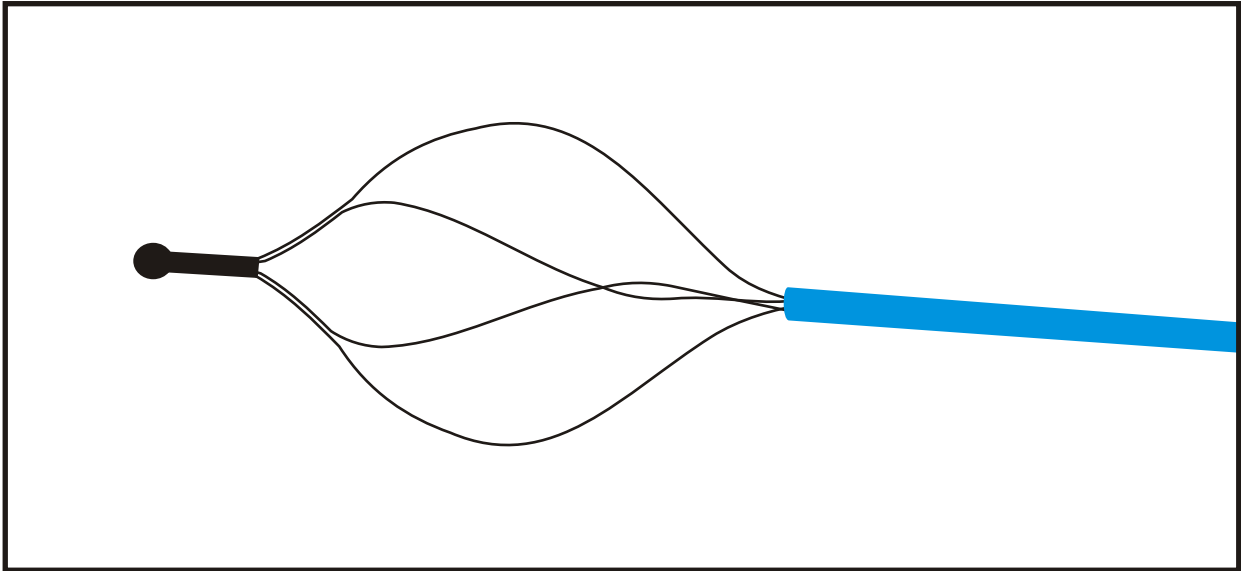

Ordering Information : Mention the product code x quantity required.

Reference	Product Name	Basket Diameter	Working Length
SMMB-P	Pancreatic Basket	15 mm	230 cm

Choledocho Basket

Used to removal of stone through Choledocho Scope
from G.I. Tract .

Technical Information

Sheath Diameter - 3 Fr

Availability- Individually packed. Sterile For single use only.

Length - 325 cm.

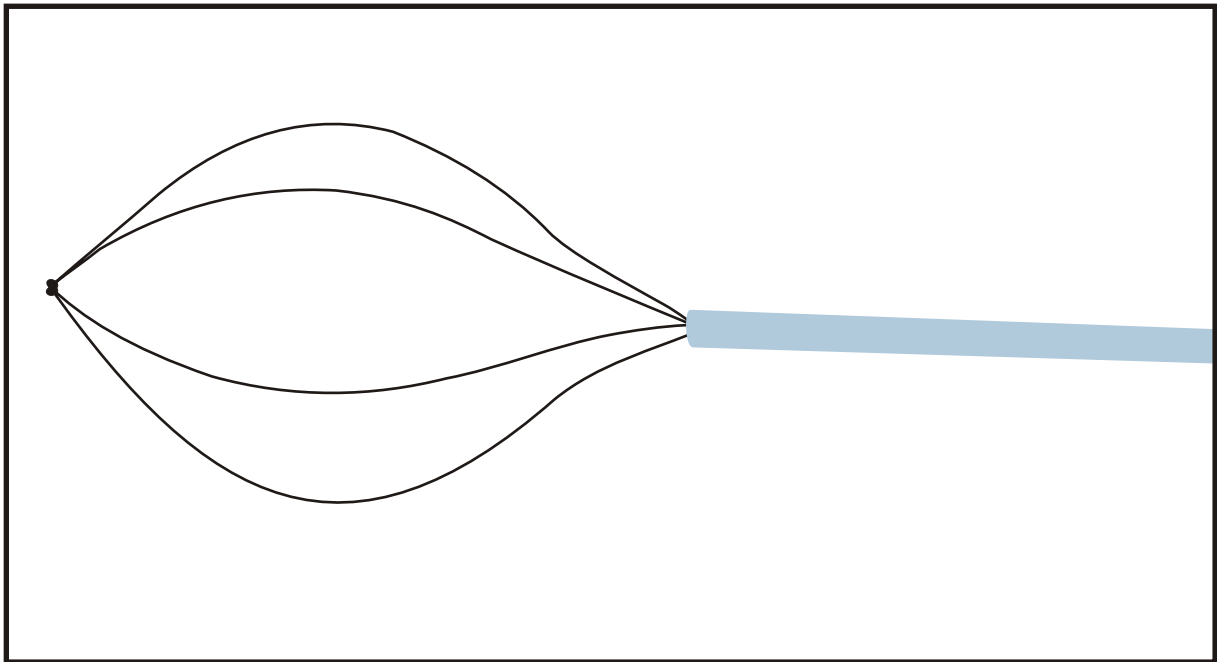

Ordering Information : Mention the product code x quantity required.

Reference	Product Name	Basket Diameter	Sheath Diameter
SMMB-CB	Choledocho Basket	15 mm	3 Fr.

Clipping Device

Used to mechanically binds blood vessels

Technical Information

Working length 165/230cm

Sheath diameter 2.6 mm

Availability - sterile for single use only.

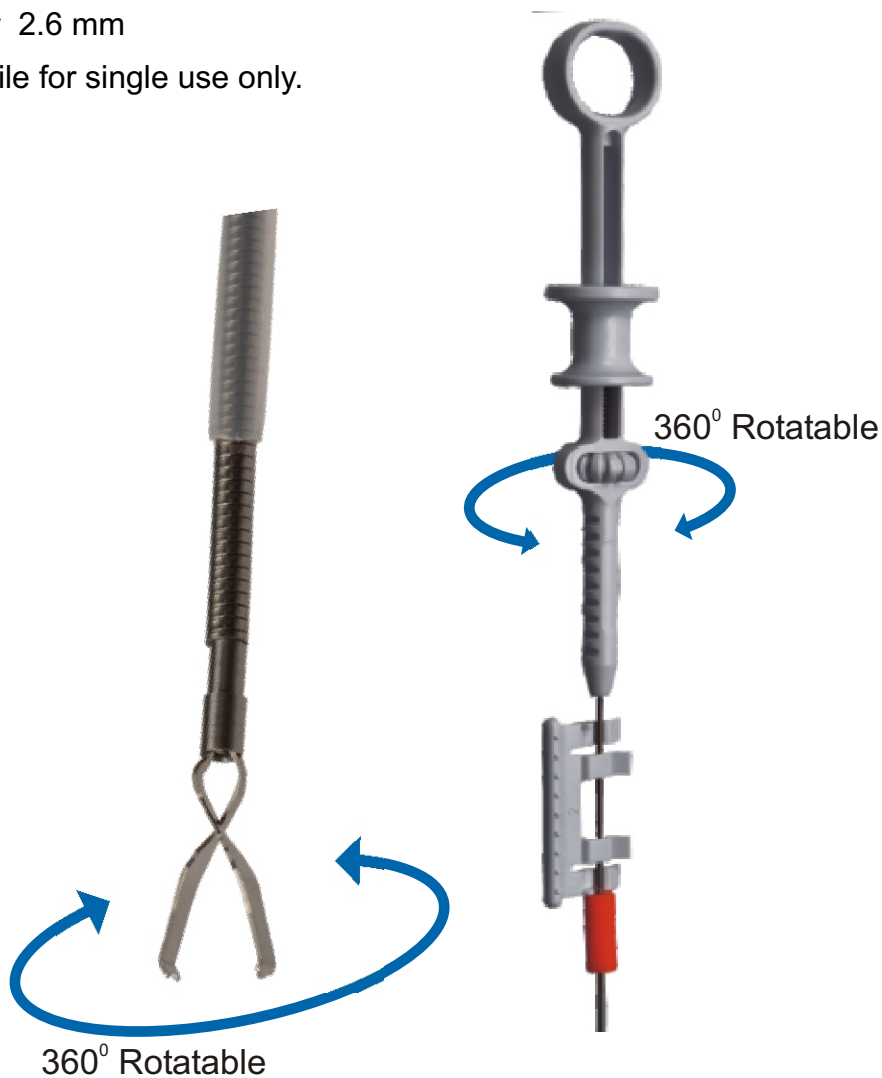

Ordering Information : Mention the product code x quantity required.

Reference	Product Name	Length	Sheath Diameter
S-CD-16	CLIPPING DEVICE	165cm	2.6mm
S-CD-21	CLIPPING DEVICE	230cm	2.6 mm

Endoclip Applicator

Used to deliver clips for endoclip

Technical Information

Working length 190cm

Compatible with instrument channel 2.8mm

Sync-rotation accuracy

Comfortable handle with perfect control feeling

Applicator is supplied non-sterile/sterile and it can be reused
(depends as per country law of user)

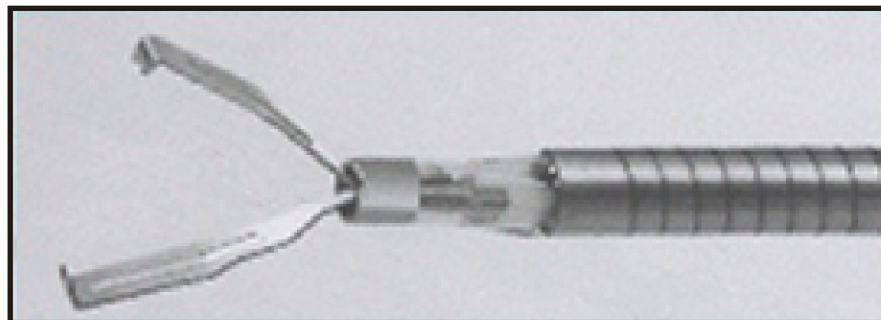
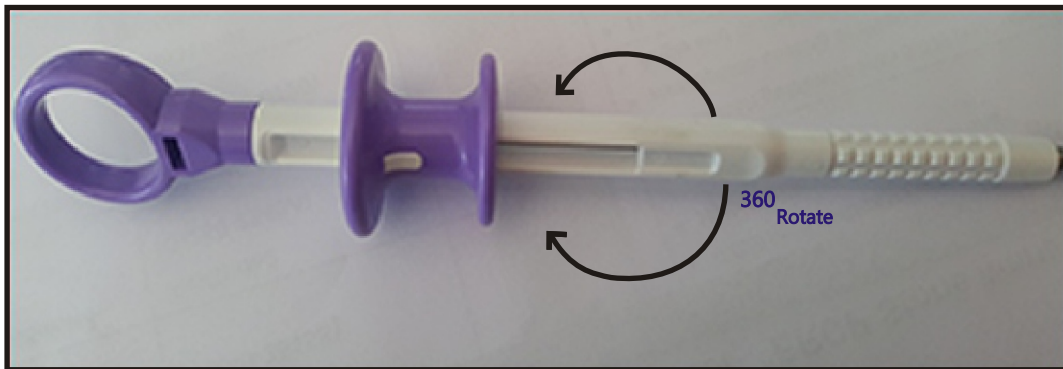

Ordering Information : Mention the product code x quantity required.

Reference	Product Name	Sheath Diameter	Working Length
S-EC-19A	ENDOCLIPAPPLICATOR	2.70mm	190cm

Clips for endoclip

Used to mechanically bind blood vessels

Indications

Hemostasis for: mucosal/submucosal defects <3cm, bleeding ulcers/arteries <2mm, surgery sites, closure of GI luminal perforance

Technical Information

Jaw angle = 135°

Distance between open clips ≥ 8mm

Clips for endoclip is supplied sterile

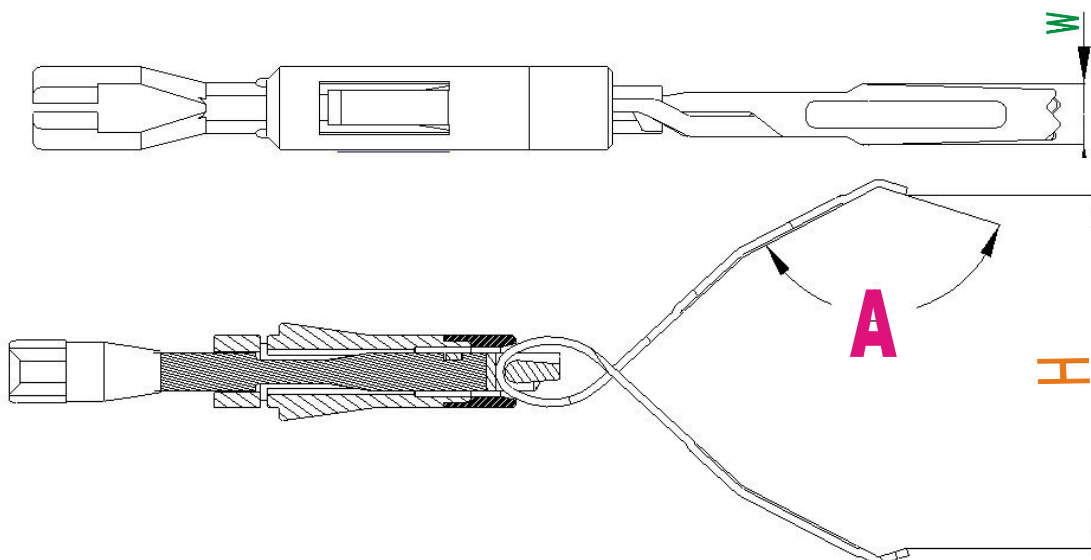

Ordering Information : Mention the product code x quantity required.

S-CL-EC Minimum order Qty. is 20 pcs/box

Reference	Product Name	Width W	Distance between open clips H	Jaw Angle A
S-CL-EC	Clips for Endoclips	1.4mm	≥ 8mm	135°

Endoknot

Used for Endoscopic knotting before cut / coagulation in GI to prevent excessive bleeding.

Bio absorbable thread enhance more indications

Technical Information

Working length 230cm

Compatible with instrument channel 2.8mm

Loop Diameter 30mm & 40mm

Sheath diameter 2.5 mm

Supplied sterile and it is for single use



Ordering Information : Mention the product code x quantity required.

Reference	Product Name	Loop ϕ	Required Channel ϕ	Working Length
S-EK-30	ENDOKNOT	30mm	2.8mm	230cm
S-EK-40	ENDOKNOT	40mm	2.8mm	230cm

Suction Coagulation Probe

Used for Suction & Coagulation during Endoscopic Mucosal Resection.

Technical Information

Working Length - 230 cm

Tip Diameter - 2.0 mm

Availability - Sterile, for single use only.



Ordering Information- - Mention product code x quantity required

Reference	Product Name	Sheath Ø
SSCP	Suction Coagulation Probe	2.5 mm

Eus Needle

Used for aspiration biopsy to diagnose and stage GI lesions, the tip provides sampling by employing ultrasound technology to guide the needle.

Technical Information

Working Length - 140 cm

Needle Tip - 19/22 swg

Handle & Sheath is Autoclavable up to 10 times at 140°C

Needle & Stylet is available in Sterile pack

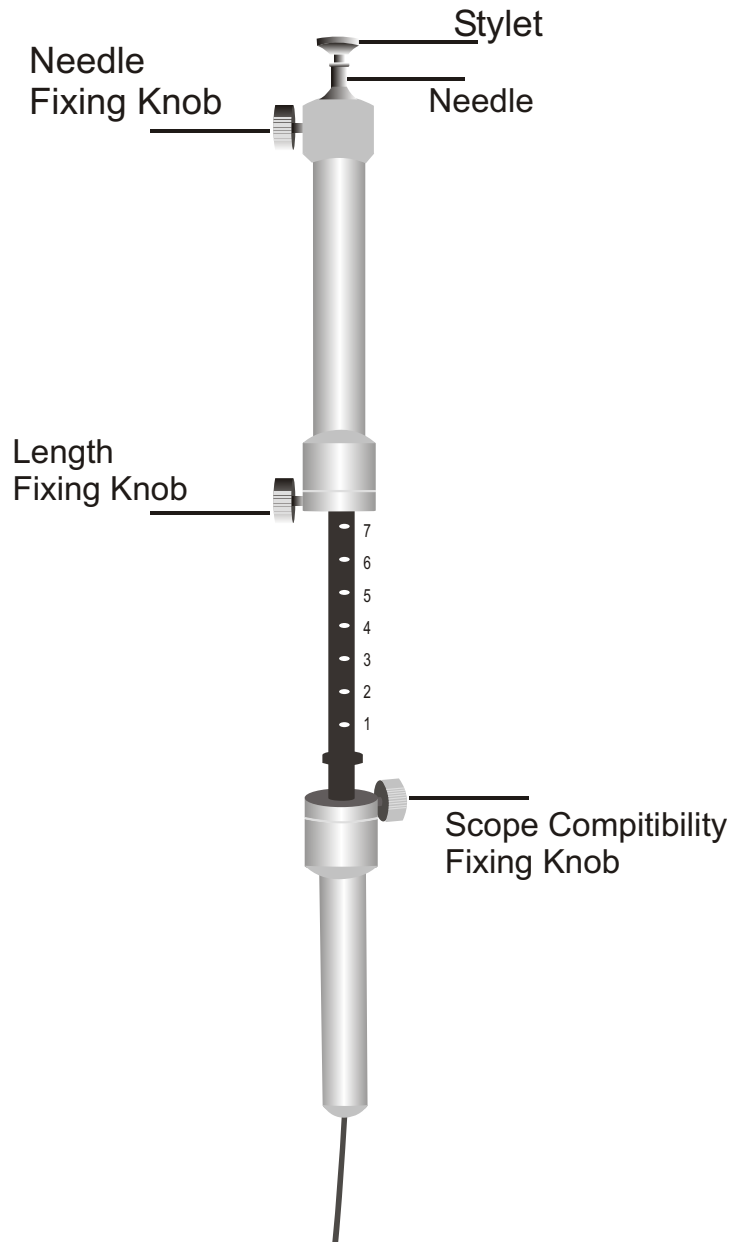
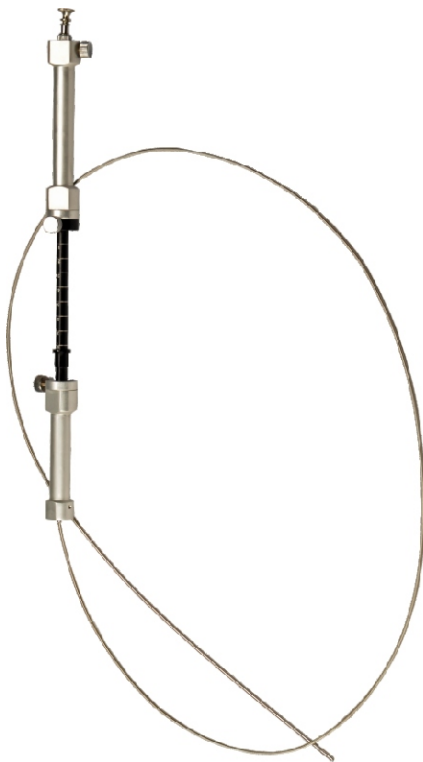





Ordering Information- - Mention product code x quantity required

Reference	Product Name	Sheath Ø	Needle Gauge	Length
S-EUS-N - 19	EUS Needle	2.50 MM	19 SWG	140 cm
S-EUS-N - 22	EUS Needle	2.55 MM	22 SWG	140 cm
S-EUS-NS-19	Needle & Stylet only	-	19 SWG	-
S-EUS-NS-22	Needle & Stylet only	-	22 SWG	-

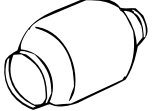

EUS Balloon

Acoustic coupling of the ultrasonic transducer to the gastrointestinal wall requires application of fluid as interface between the transducer and the wall. This is achieved by EUS Balloon.



FOR OLYMPUS ECHO ENDOSCOPES

REFERENCE	Compatible with Model	OPENED SIDE	SCATCH IMAGE
SS1070000	GF-UM160 / GF-UM130 / GF-UMQ130 / GF-UM20 / JF-UM20 / RU-75M-R1 / RU-12M-R1	2	
SS1830000	GF-UC140P-AL5 / GF-UCT140-AL5 / GF-UC140P-DO5 / GF-UCT140-DO5 / GF-UC160P-OL5 / GF-UCT160-OL5 / GF-UC30P / GF-UMD140P	1	
SS1460000	CF-UM20	2	
SS2230000	GF-UE160-AL5	2	

FOR-PENTAX ECHO-ENDOSCOPES

REFERENCE	Compatible with Model	OPENED SIDE	SCATCH IMAGE
SS1470000	EG-3870UTK / EG-3830UT / FG-34UX / FG-36UX / FG-38UX / EG-3630U	1	
SS2070000	EG-3670URK / EG-3630UR	2	

FOR Fujinon ECHO ENDOSCOPE

REFERENCE	Compatible with Model	OPENED SIDE	SCATCH IMAGE
SS2660000	EG-530UR	2	
SS2800000	EG-530UT	1	

Cystostome

To electro surgically cannulate the transgastric or transduodenal wall and into a pancreatic pseudocyst that is visibly bulging into the gastrointestinal tract.

Technical Information

Size - 6 - 7 - 8 - 10 Fr.

Length - 230 cm

Availability - Sterile-for single use only.



Ordering Information- - Mention product code x quantity required

Reference	Product Name	Size
S - CYS - 6	Cystostome	6 Fr.
S - CYS - 7	Cystostome	7 Fr.
S - CYS - 8	Cystostome	8 Fr.
S - CYS - 10	Cystostome	10 Fr.

Esophageal Dilator

Used to Dilate Esophageal Strictures over previously placed wire guide.

Available Sizes - 5mm to 20mm Outer Diameter.
Other sizes can be produced on specific request.



Soft, Flexible and Radioopaque Tip & Radioopaque Junction.
Gradual Tapering.
Low friction lumen surface.
Compatible with 0.038 inch wire guide.

- Dilator Size - Diameter - 5 mm. to 20 mm. Length 100 cm. , 70 cm.
Availability - (1) Set of 6 Pcs. Even diameter. / Odd diameter.
(2) Set of 12 Pcs. & 16 Pcs.
(3) Non Sterile & Reusable



Set includes 1x Shaili Flexible spring tip Guide Wire 250 cm long. Carrying case is available with order of set only.

Ordering Information- Mention the product code x quantity required.

Reference	Outer Ø	Length
SED-500	5 mm.	100 cm.
SED-600	6 mm.	100 cm.
SED-700	7 mm.	100 cm.
SED-800	8 mm.	100 cm.
SED-900	9 mm.	100 cm.
SED-1000	10 mm.	100 cm.
SED-1100	11 mm.	100 cm.
SED-1200	12 mm.	100 cm.
SED-1300	13 mm.	100 cm.
SED-1400	14 mm.	100 cm.
SED-1500	15 mm.	100 cm.
SED-1600	16 mm.	100 cm.
SED-1700	17 mm.	100 cm.
SED-1800	18 mm.	100 cm.
SED-1900	19mm.	100 cm.
SED-2000	20 mm.	100 cm.

Reference	Outer Ø	Length
SED-570	5 mm.	70 cm.
SED-670	6 mm.	70 cm.
SED-770	7 mm.	70 cm.
SED-870	8 mm.	70 cm.
SED-970	9 mm.	70 cm.
SED-1070	10 mm.	70 cm.
SED-1170	11 mm.	70 cm.
SED-1270	12 mm.	70 cm.
SED-1370	13 mm.	70 cm.
SED-1470	14 mm.	70 cm.
SED-1570	15 mm.	70 cm.
SED-1670	16 mm.	70 cm.
SED-1770	17 mm.	70 cm.
SED-1870	18 mm.	70 cm.
SED-1970	19 mm.	70 cm.
SED-2070	20 mm.	70 cm.

Spring Tip Steel Guide Wire

Used to Guide Esophageal Dilators for Dilatation.

Specially designed Flexible atraumatic tip
Spring base and metallic wire shaft are interlocked.
Joint of Spring and wire shaft is tapered to stop guide wire getting stuck in the dilator.
Smooth surface finish offers easy passage through dilator lumen during dilatation procedure.
Availability - Sterile, Single Use.

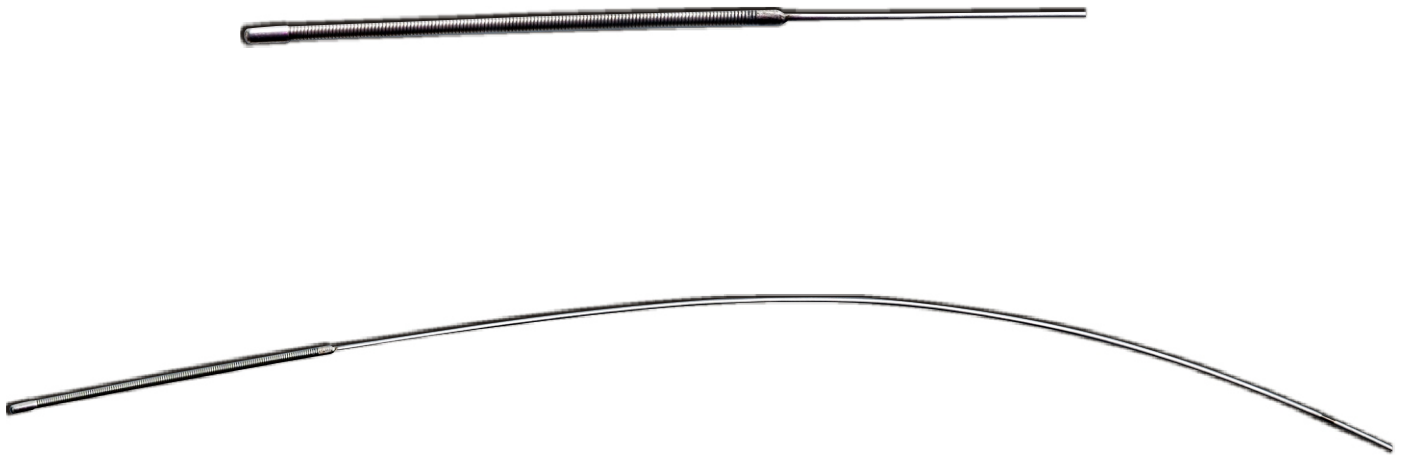

Ordering Information- Mention the product code x quantity required.

Reference	Product Name	Length	Tip Ø
SMGW	Spring Tip Steel Guide Wire	250 cm	2.00 mm
SMGW-M	Spring Tip Steel Guide Wire Marked	250 cm	2.00 mm

Esophageal Dilator

Used to Dilate Esophageal Strictures over previously placed wire guide.

Available Sizes - 5mm to 20mm Outer Diameter.
Other sizes can be produced on specific request.

Soft, Flexible and Radioopaque Tip & Radioopaque Junction.
Gradual Tapering.
Low friction lumen surface.
Compatible with 0.038 inch wire guide.

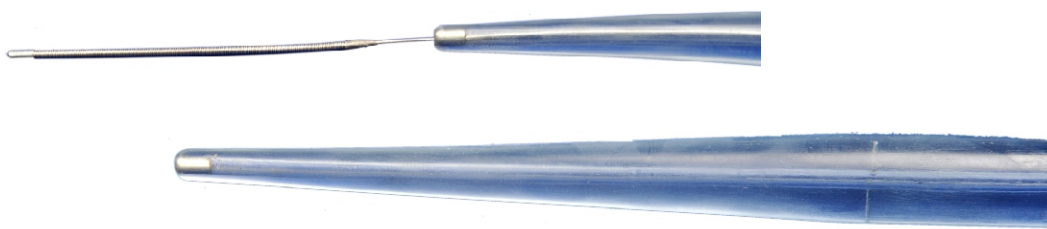

Dilator Size - Diameter - 5 mm. to 20 mm. Length 100 cm. , 70 cm.
Availability - Sterile for single use only

Ordering Information- Mention the product code x quantity required.

Reference	Outer Ø	Length
SED-500-S	5 mm.	100 cm.
SED-600-S	6 mm.	100 cm.
SED-700-S	7 mm.	100 cm.
SED-800-S	8 mm.	100 cm.
SED-900-S	9 mm.	100 cm.
SED-1000-S	10 mm.	100 cm.
SED-1100-S	11 mm.	100 cm.
SED-1200-S	12 mm.	100 cm.
SED-1300-S	13 mm.	100 cm.
SED-1400-S	14 mm.	100 cm.
SED-1500-S	15 mm.	100 cm.
SED-1600-S	16 mm.	100 cm.
SED-1700-S	17 mm.	100 cm.
SED-1800-S	18 mm.	100 cm.
SED-1900-S	19mm.	100 cm.
SED-2000-S	20 mm.	100 cm.

Reference	Outer Ø	Length
SED-570-S	5 mm.	70 cm.
SED-670-S	6 mm.	70 cm.
SED-770-S	7 mm.	70 cm.
SED-870-S	8 mm.	70 cm.
SED-970-S	9 mm.	70 cm.
SED-1070-S	10 mm.	70 cm.
SED-1170-S	11 mm.	70 cm.
SED-1270-S	12 mm.	70 cm.
SED-1370-S	13 mm.	70 cm.
SED-1470-S	14 mm.	70 cm.
SED-1570-S	15 mm.	70 cm.
SED-1670-S	16 mm.	70 cm.
SED-1770-S	17 mm.	70 cm.
SED-1870-S	18 mm.	70 cm.
SED-1970-S	19 mm.	70 cm.
SED-2070-S	20 mm.	70 cm.

Esophageal Metal Stent

Used to treat Tracheoesophageal Fistulas and expansion treatment of the Esophageal Stenosis caused by Esophageal Carcinoma, Chemical Injuries, Cardiac Carcinoma, Anastomatic stenosis, and other Traumas, which are surgical contraindicated.

Technical Information

Radiotherapy compatible.

Esophageal Stents with Introducer system.

Expanded Stent diameter. - 18mm.

Stent wire diameter. - 0.20mm.

Expanded Stent length - 50mm / 100mm / 120mm / 150mm covered stent.

Compatible with 0.038 inch wire guide.

Availability - Sterile - For single use only.

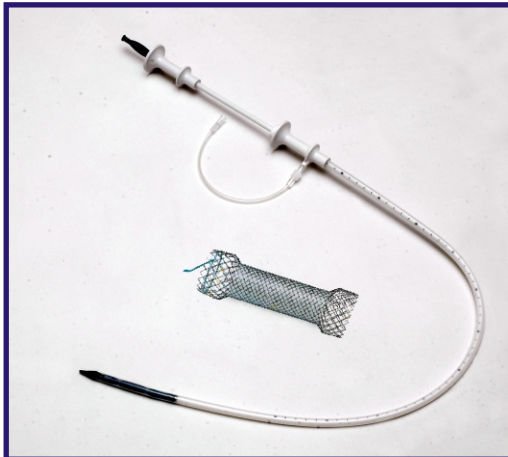

Ordering Information- Mention the product code x quantity required.

Reference	Product Name	Stent Length
S - ES - 5	Esophageal Metal Stent	50mm
S - ES - 10	Esophageal Metal Stent	100mm
S - ES - 12	Esophageal Metal Stent	120mm
S - ES - 15	Esophageal Metal Stent	150mm

Cytology Brush

Used to collect cells from the upper and lower
Gastrointestinal Tracts

Technical Information

Length-170cm / 230cm & 325cm

Wire Guide Compatibility-0.035"

Availability- Individually packed. Sterile For single use only.



Ordering Information : Mention the product code x quantity required.

Reference	Product Name	Required Channel Ø	Length
S - CY-170	CYTOLOGY BRUSH	2.8 mm	170 cm
S - CY-230	CYTOLOGY BRUSH	2.8 mm	230 cm
S - CY-DL	WIRE GUIDED CYTOLOGY BRUSH	2.8 mm	230 cm
S - CY - S	CYTOLOGY BRUSH	1.2 mm	325 cm

Esophageal Gastric Balloon Retrieval Device

Used for retrieval of Esophageal Gastric Balloon

Technical Information :

Compatible with 2.8 mm. instrument channel.

Sheath diameter 2.5 mm

Working length 170 cm.

Supplied Sterile, for single use only .

Excellent and secure grip to retrieve deflated Esophageal Gastric Balloon

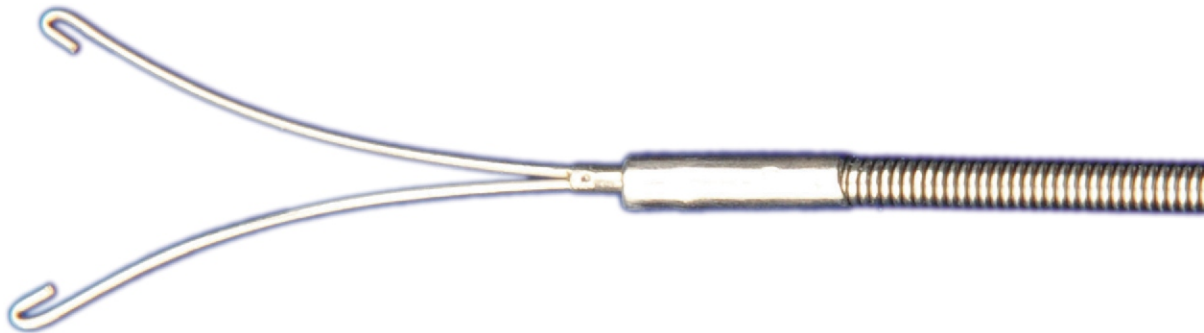

Ordering Information- Mention the product code x quantity required.

Reference	Product Name	Working Length	Required Channel Ø
SEGBRD	Esophageal Gastric Balloon Retrieval Device	170 cm	2.8 mm

Esophageal Gastric Balloon Deflation Device

Used to deflate previously placed Esophageal Gastric Balloon

Technical Information :

Sheath Diameter - 2.5mm

Working length - 170cm

Supplied sterile, for single use only.

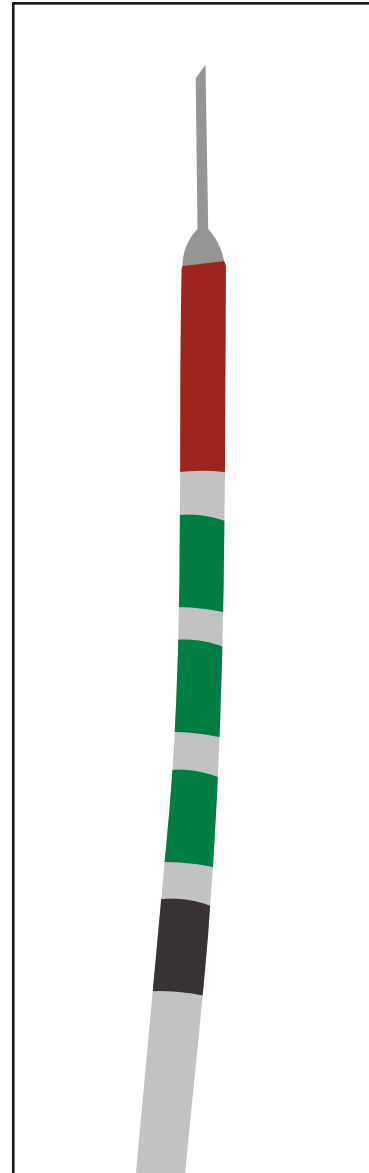

Ordering Information- Mention the product code x quantity required.

Reference	Product Name	Working Length	Required Channel Ø
SEGBDD	Esophageal Gastric Balloon Deflation Device	170 cm	2.8 mm

Naso Biliary Drainage Catheter

Used to drain bile from obstructed biliary duct through Naso.

Technical Information

Size - 6fr / 7fr. / 8.5fr. /10fr.

Working Length - 250cm

Sterile for single use only.



Ordering Information : Mention the product code x quantity required.

Reference	Product Name	Size
S-NBDC-6	Naso Biliary Drainage catheter	6 fr
S-NBDC-7	Naso Biliary Drainage catheter	7 fr
S-NBDC-8.5	Naso Biliary Drainage catheter	8.5 fr
S-NBDC-10	Naso Biliary Drainage catheter	10 fr

Naso Jejunal Feeding Tube

Nasojejunal feeding tubes are frequently used for long-term enteral Nutrition.

Technical Information

Feeding tube size diameter - 10, 12, 14, & 16 fr

Working length - 120 cm & 155 cm

Wire guide compatible -0.038 inch.

Sterile, single use only.

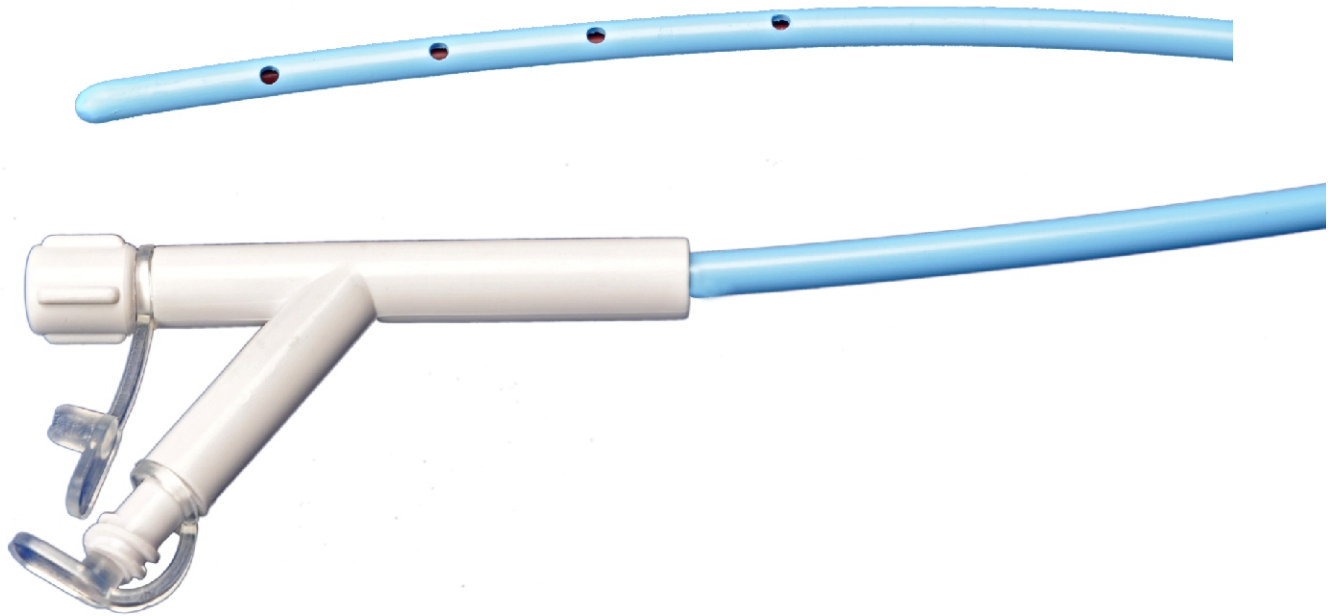

Ordering Information : Mention the product code x quantity required.

Reference	Product Name	Size	Length
S-NJFT-10120	NASO JEJUNAL FEEDING TUBE	10FR	120CM
S-NJFT-12120	NASO JEJUNAL FEEDING TUBE	12FR	120CM
S-NJFT-14120	NASO JEJUNAL FEEDING TUBE	14FR	120CM
S-NJFT-16120	NASO JEJUNAL FEEDING TUBE	16FR	120CM
S-NJFT-10155	NASO JEJUNAL FEEDING TUBE	10FR	155CM
S-NJFT-12155	NASO JEJUNAL FEEDING TUBE	12FR	155CM
S-NJFT-14155	NASO JEJUNAL FEEDING TUBE	14FR	155CM
S-NJFT-16155	NASO JEJUNAL FEEDING TUBE	16FR	155CM

Spray Probe

Used to Spray Dyeing.

Technical Information :

Working length - 230 cm

Atraumatic metal tip

Availability - Sterile, for single use only.

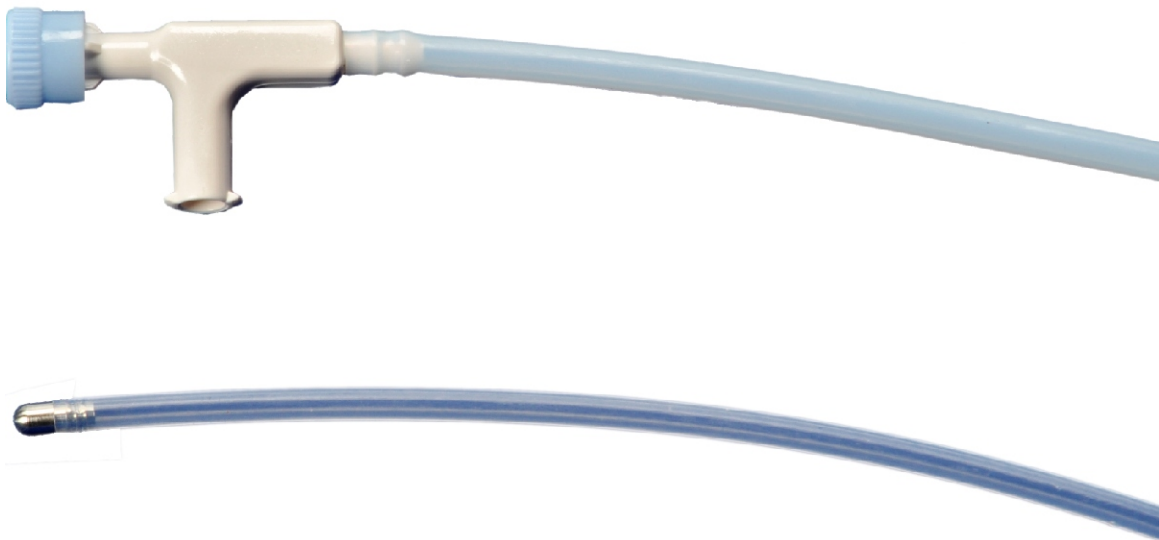

Ordering Information- - Mention product code x quantity required

Reference	Product Name	Sheath Ø
SSP	Spray Probe	2.5 mm

VGM'S HAEMOSEAL POWDER DEVICE

INDICATIONS

I As a tissue healant / sealant : Chronic Non-healing Ulcers, Peptic Ulcers, Post EMR / ESD

II As a haemostat during active or ceased bleed : Duodenal, Gastric or Esophageal Ulcer without visible vessel, Erosions, Portal Hypertensive Gastropathy, Colonic Ulceration including UC Radiation Parotitis

Source : Egg cell membrane

Composition : Collagen Powder

Collagen is a type of fibrous protein. It supports and connects body tissue such as bones, tendons, ligaments, muscles and keeps the body from falling apart. Collagen works with elastin to give strength and firmness to the body's tissue. It strengthens blood vessels and plays a role in tissue development. It is attached to cell membrane via several types of protein, including fibronectin and integrin. The cell membrane is the biological membrane separating the interior of a cell from the outside environment. It also serves as the attachment point for both the intracellular cytoskeleton and, if present, the extracellular cell wall.

Function : Studies have proved the importance of collagen in haemostasis. [It is a process which causes bleeding to stop]. In heavy powder form, collagen works with the body's natural coagulation cascade. Primary hemostasis occurs, blood platelets aggregate on the collagen, releasing coagulation factors. A fibrin clot is formed creating a physiological plug.

Collagen haemostasis effectively stops capillary bleeding. Shaili Haemoseal is a unique powder delivery system to spray collagen powder directly to the designated site through the scope in to gastrointestinal tract. This product with the characteristics of absorbability, adhering to tissue, non-expansion after getting wet, etc. has the functions of repairing nerve fibers, promoting formation of regenerated capillary and stimulating regeneration of cells. It can promote initiative repair and functional recovery of scar, reduce pigmentation and improve healing quality.

Precautions and Contraindications :

- (1) Do not use to people with known allergy to collagen. If allergy happens, just stop using.
- (2) Do not use in vessel lacuna because of blocking risk.
- (3) With coagulation dysfunction and during anticoagulation treatment, hemostasis effect of Haemoseal will be reduced or eliminated.

Technical specification : This biological protein contains 100% natural, non synthetic and free from any toxic content.

System preparation:

1. Start pump
2. Attach pump tubing into the probe
3. Attach powder syringe into the probe
4. Make 2way stop cock in off position
5. Insert the probe into the scope channel
6. Locate the probe at desired position
7. Make 2 way stop cock in on position
8. Push the plastic air pusher to spray the powder

Ordering information : S-FBPRO-1 means 1 gm FIBRO PROTEIN

REFERENCE	PRODUCT NAME	SHEATH DIAMETER
S-HSP	Haemoseal Pump	2.5mm
S-HSPR	Haemoseal Probe	
S-FBPRO-1	FIBRO PROTEIN	

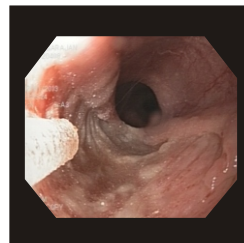
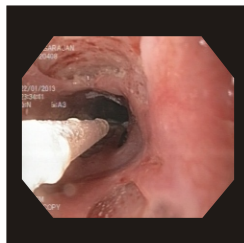
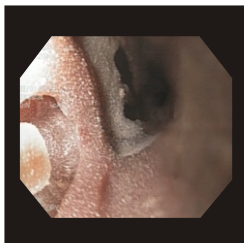
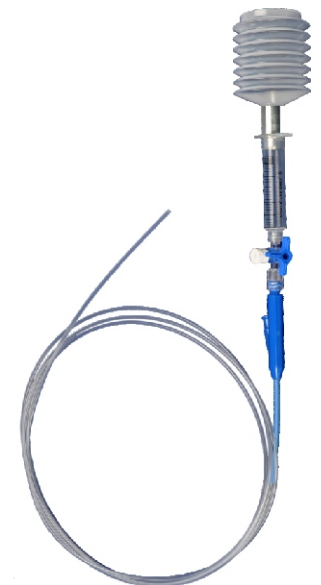
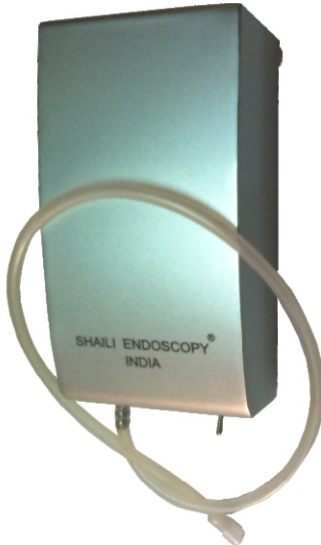

Miscellaneous Products

Foreign Body Retrieval Hood



Bite Block Disposable with
or without Strap



Accessories Hanger



Endoscope Hanger



BRONCHOSCOPY



Aspiration Needle

USED FOR ENDOSCOPIC ASPIRATION FROM LUNGS AND BRONCHIOLE

Technical Information -

Sharp and short bevel. 19 / 21 swg
Working length 110cm
Compatible with 2.8 mm instrument channel
Availability - sterile for single use only.
Needle length 15 mm

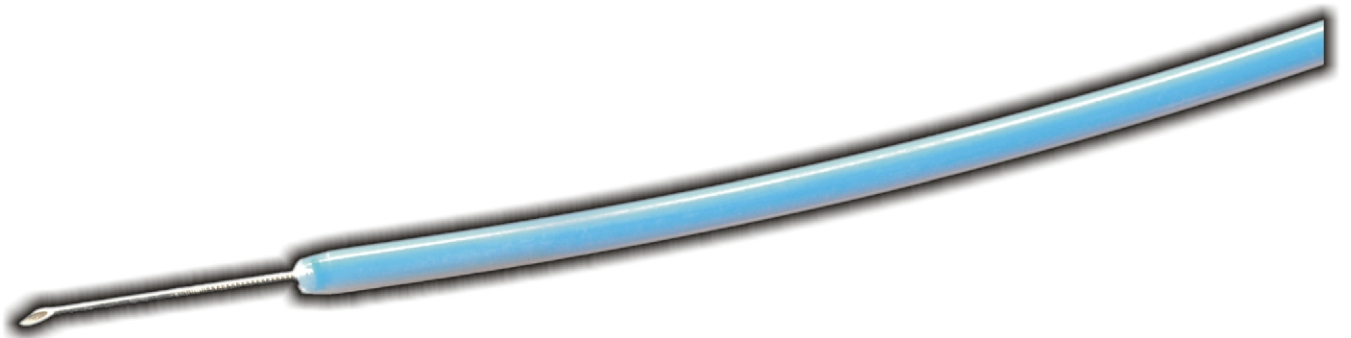

Ordering Information- Mention the product code x quantity required.

Reference	Product Name	Needle Gauge	Working Length	Required Channel Ø
SAN - 19	ASPIRATION NEEDLE	19 G	110 cm	2.8 mm.
SAN - 21	ASPIRATION NEEDLE	21 G	110 cm	2.8 mm.

Biopsy Forcep

USED ENDOSCOPICALLY TO OBTAIN MUCOSAL TISSUE SAMPLES FROM BRONCHIOLE FOR MICROSCOPIC HISTOPATHOLOGICAL EXAMINATION.

Technical Information :

Availability - Sterile For single use only.
Compatible With - 2.0 / 2.8 mm instrument channel
Length : 110 Cm
Individually Packed

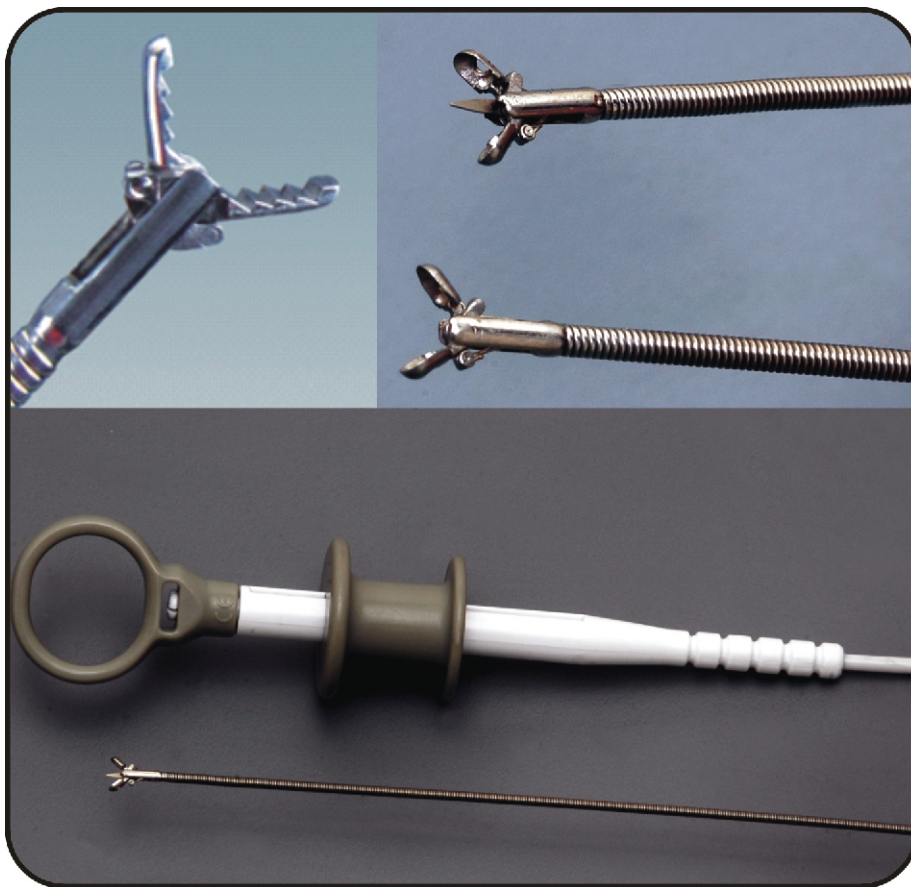

Ordering Information- Mention the product code x quantity required.

Reference	Product Name	Type	Required Channel Ø	Working length
S- BF- B	Biopsy Forcep	Without Spike	2.0/2.8 mm	110 cm

Cleaning Brush

Used to clean endoscope channel.

Technical Information

Type both end bristles

Shaft plastic coated wire

Semi soft and channel friendly bristles for cleaning of endoscope channel.

Atraumatic tip

Compatible with 2.0 / 2.8 mm instrument channel

Length 110cm

Individually packed

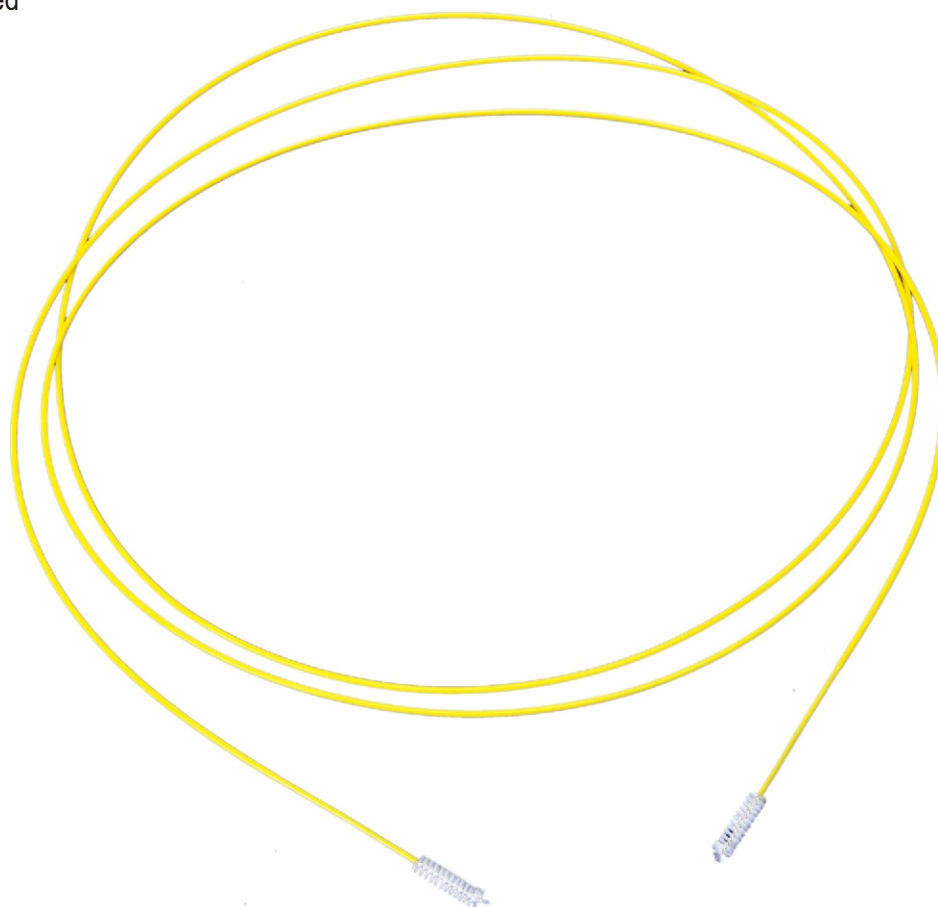

Ordering Information- Mention the product code x quantity required.

Reference	Product Name	Required Channel Ø	Working Length
S-CB-BR	Cleaning Brush Single use	2.0 mm.	110 cm
S-CB-BR-R	Cleaning Brush Reusable	2.8 mm.	110 cm

Cytology Brush

USED TO COLLECT CELLS FROM LUNGS AND BRONCHIOLE.

Technical information :

Length 110 cm

Required channel diameter 2.0 / 2.8mm

Availability - Sterile for single use only.

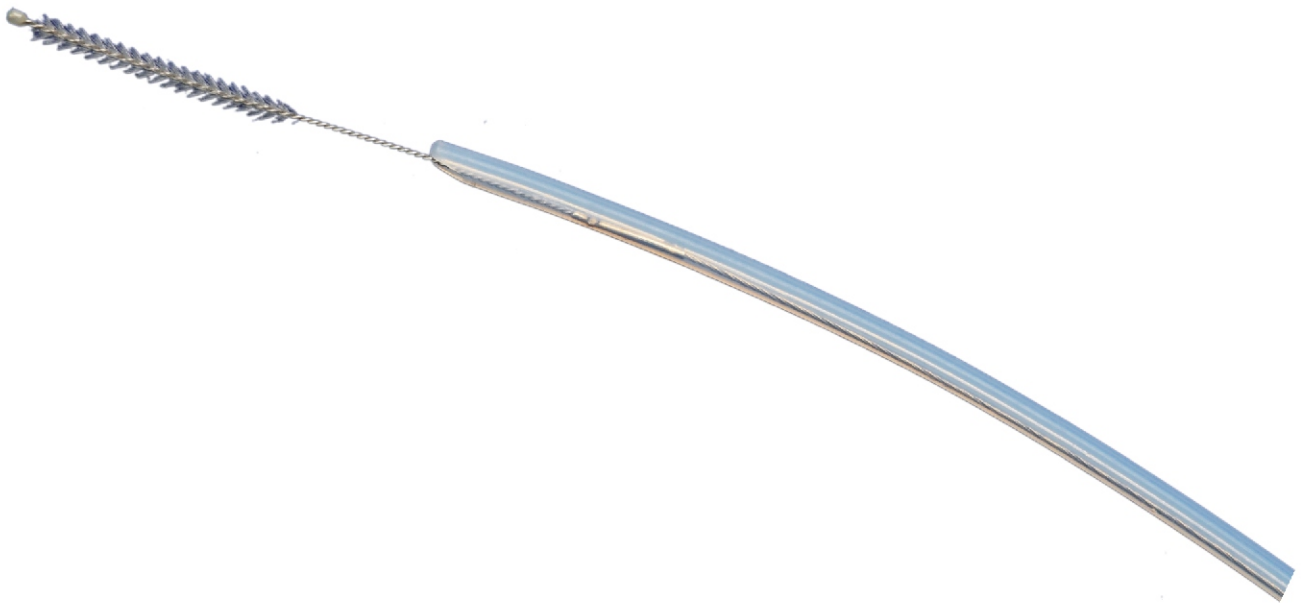

Ordering Information : Mention the product code x quantity required.

Reference	Product Name	Required Channel Ø	Length
S - CY - B-28110	CYTOLOGY BRUSH	2.8 mm	110 cm
S - CY - B-20110	CYTOLOGY BRUSH	2.0 mm	110 cm

Foreign Body Holding Forcep 2 Prong, 3 Prong, Memory Basket

USED TO RETRIEVE FOREIGN BODY FROM BRONCHIOLE TRACT.

Technical Information :

Compatible with 2.0 / 2.8 mm instrument channel

Working length 110cm

Sterile for single use only



Ordering Information- Mention the product code x quantity required.

Reference	Product Name	Working Length	Required Channel Ø	Jaws
SFBH- 218-B	2 prong	110 cm.	2.0 mm	2 prong
SFBH- 318-B	3 prong	110 cm.	2.0 mm	3 prong
SMMB- BR	Memory Basket	110 cm.	2.0 mm	Basket

Urology

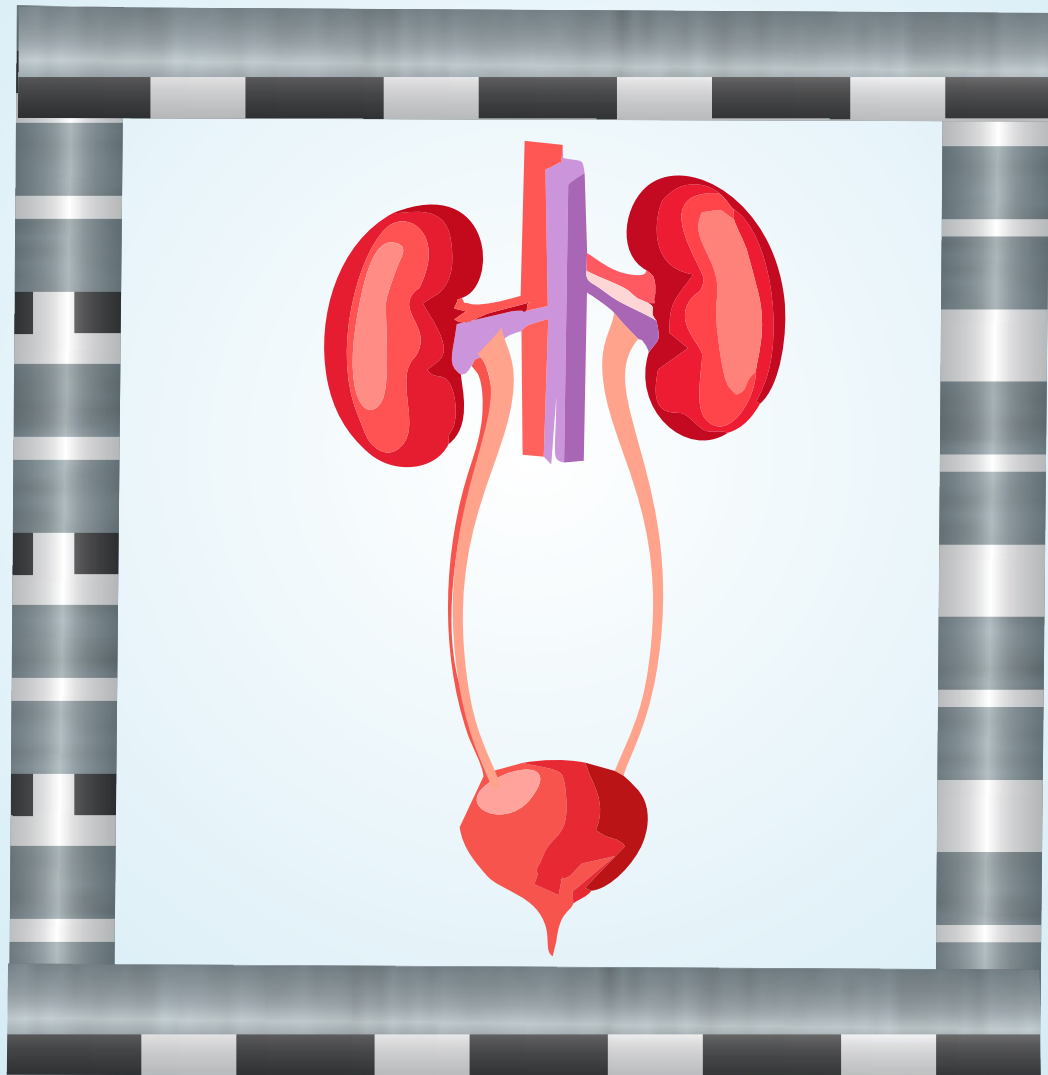

Hydra Neg Guide Wire

Used to gain access Urology tract for access and exchange of accessories.

Technical Information :

Size Diameter - 0.025 inch. / 0.032 inch / 0.035 inch / 0.038 inch.

Length - 150 cm.

Tip - Straight / Angle / J, with Extra Filifom Wire

Availability - Individually packed.

Sterile For single use only.

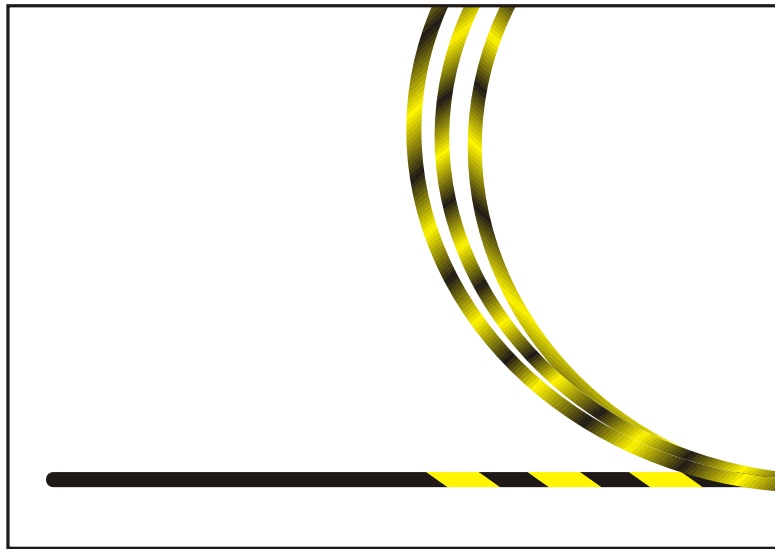

Ordering Information :

Reference	Product Name	Wire Ø
S-HYNEG-025-S-150	HYDRA NEG GUIDE WIRE	0.025 STRAIGHT
S-HYNEG-025-A-150	HYDRA NEG GUIDE WIRE	0.025 ANGULATED
S-HYNEG-025-J-150	HYDRA NEG GUIDE WIRE	0.025 J TIP
S-HYNG-032-S-150	HYDRA NEG GUIDE WIRE	0.032 STRAIGHT
S-HYNEG-032-A-150	HYDRA NEG GUIDE WIRE	0.032 ANGULATED
S-HYNEG-032-J-150	HYDRA NEG GUIDE WIRE	0.032 J TIP
S-HYNEG-035-S-150	HYDRA NEG GUIDE WIRE	0.035 STRAIGHT
S-HYNEG-035-A-150	HYDRA NEG GUIDE WIRE	0.035 ANGULATED
S-HYNEG-035-J-150	HYDRA NEG GUIDE WIRE	0.035 J TIP
S-HYNEG-038-S-150	HYDRANEG GUIDE WIRE	0.038 STRAIGHT
S-HYNEG-038-A-150	HYDRA NEG GUIDE WIRE	0.038 ANGULATED
S-HYNEG-038-J-150	HYDRA NEG GUIDE WIRE	0.038 J TIP

Neg Guide Wire

Used to gain access Urology tract for access and exchange of accessories.

Technical Information

Size Diameter - 0.025 inch / 0.032 inch / 0.035 inch. / 0.038 inch.

Availability - Individually packed.

Sterile For single use only.

Length - 150 cm.

Tip - Straight / Angle / J

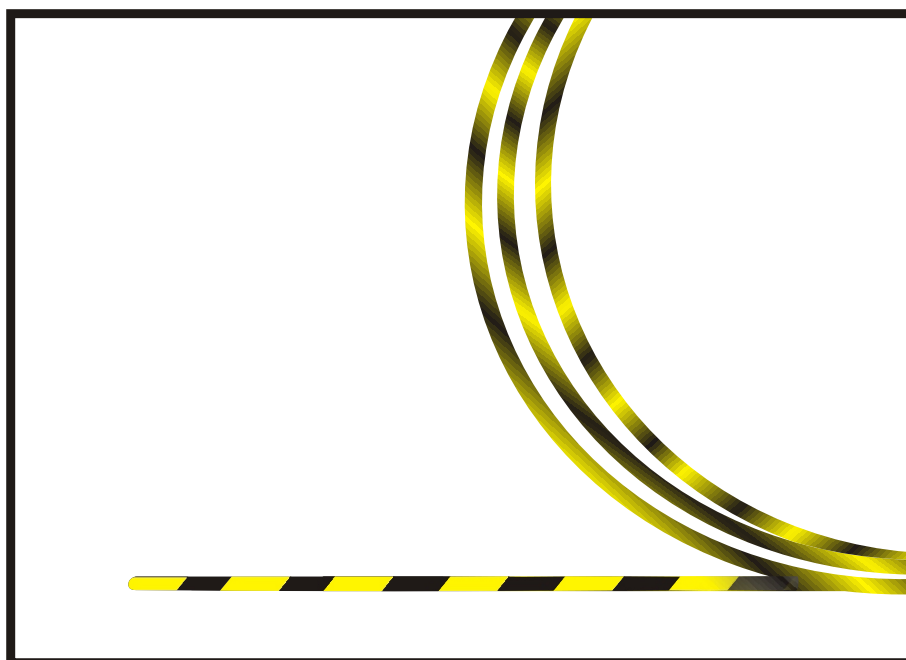

Ordering Information :

Reference	Product Name	Reference	Product Name
S-NEG-025-S-150	Neg Guide Wire 0.025 Straight	S-NEG-035-S-150	Neg Guide Wire 0.035 Straight
S-NEG-025-A-150	Neg Guide Wire 0.025 Angulated	S-NEG-035-A-150	Neg Guide Wire 0.035 Angulated
S-NEG-025-J-150	Neg Guide Wire 0.025 J Tip	S-NEG-035-J-150	Neg Guide Wire 0.035 J Tip
S-NEG-032-S-150	Neg Guide Wire 0.032 Straight	S-NEG-038-S-150	Neg Guide Wire 0.038 Straight
S-NEG-032-A-150	Neg Guide Wire 0.032 Angulated	S-NEG-038-A-150	Neg Guide Wire 0.038 Angulated
S-NEG-032-J-150	Neg Guide Wire 0.032 J Tip	S-NEG-038-J-150	Neg Guide Wire 0.038 J Tip

Hyneg Combo Guide Wire

Used to gain access Urology tract for access and exchange of accessories.

Technical Information

Size Diameter - 0.032 inch / 0.035 inch.

Availability - Individually packed.

Sterile For single use only.

One end with black hydrophilic tip / other end with exchange wire tip.

Length - 150 cm

Tip - Straight

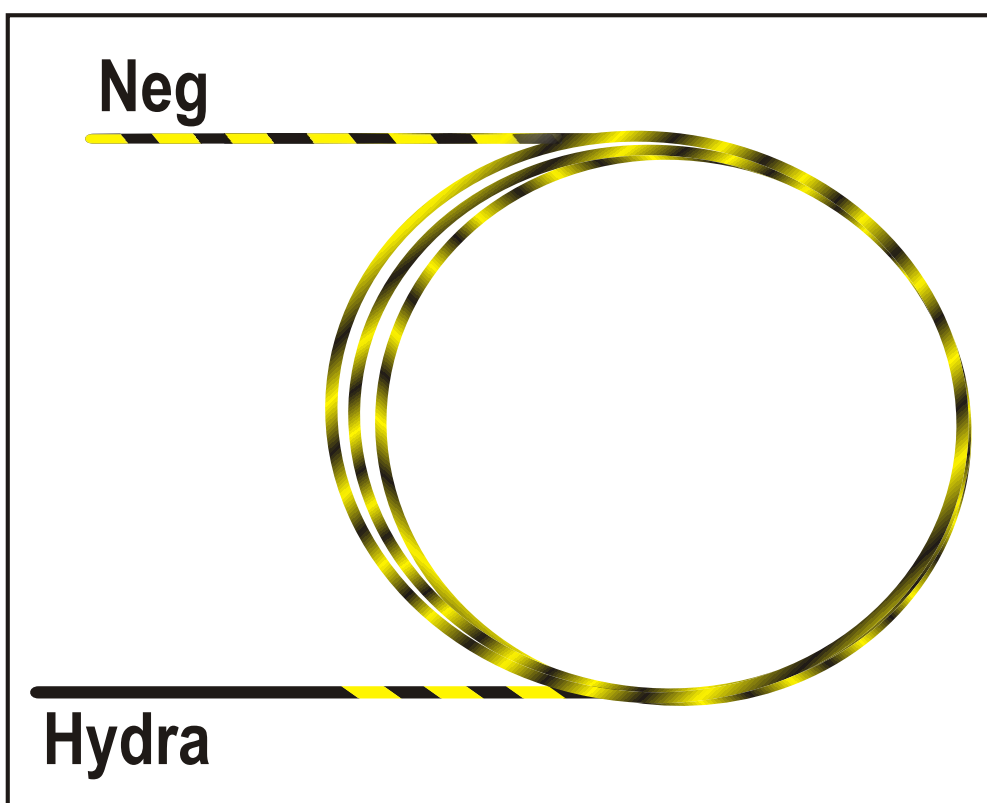

Ordering Information : Mention the product code x quantity required.

Reference	Product Name	Reference	Product Name
S-HYCG-032-S-150	Hyneg Combo Guide Wire 0.032 straight	S-HYCG-035-S-150	Hyneg Combo Guide Wire 0.035 straight

Nitinol Black Wire

Used to gain access Urology tract for access and exchange of accessories.

Technical Information

Size Diameter - 0.025 inch / 0.032 inch / 0.035 inch. / 0.038 inch.

Availability - Individually packed.

Sterile For single use only.

Length - 150 cm.

Tip - Straight / Angle / J

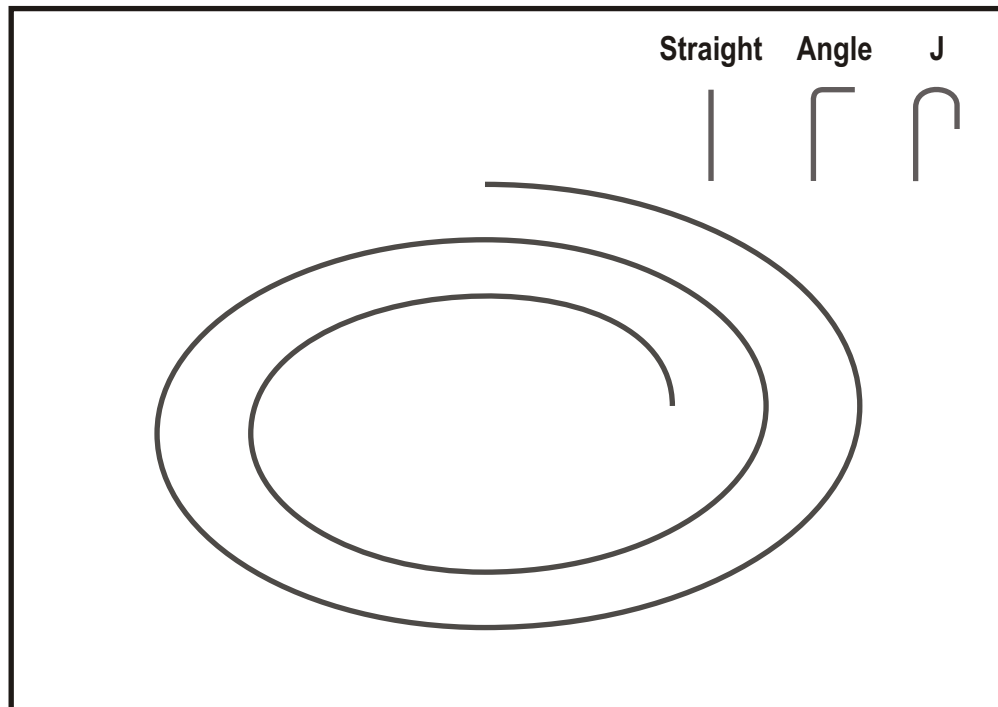

Ordering Information :

Reference	Product Name	Reference	Product Name
S-NBW-025-S-150	Nitinol Black Wire 0.025 Straight	S-NBW-035-S-150	Nitinol Black Wire 0.035 Straight
S-NBW-025-A-150	Nitinol Black Wire 0.025 Angulated	S-NBW-035-A-150	Nitinol Black Wire 0.035 Angulated
S-NBW-025-J-150	Nitinol Black Wire 0.025 J Tip	S-NBW-035-J-150	Nitinol Black Wire 0.035 J Tip
S-NBW-032-S-150	Nitinol Black Wire 0.032 Straight	S-NBW-038-S-150	Nitinol Black Wire 0.038 Straight
S-NBW-032-A-150	Nitinol Black Wire 0.032 Angulated	S-NBW-038-A X-150	Nitinol Black Wire 0.038 Angulated
S-NBW-032-J-150	Nitinol Black Wire 0.032 J Tip	S-NBW-038-J-150	Nitinol Black Wire 0.038 J Tip

Stiff Guide Wire (L' Queist)



Used to gain access endoscopically through the difficult strictures.

Technical Information

Size Diameter - 0.035 inch.

Availability - Individually packed.

Sterile For single use only.

Length - 150 cm.

Tip - Straight

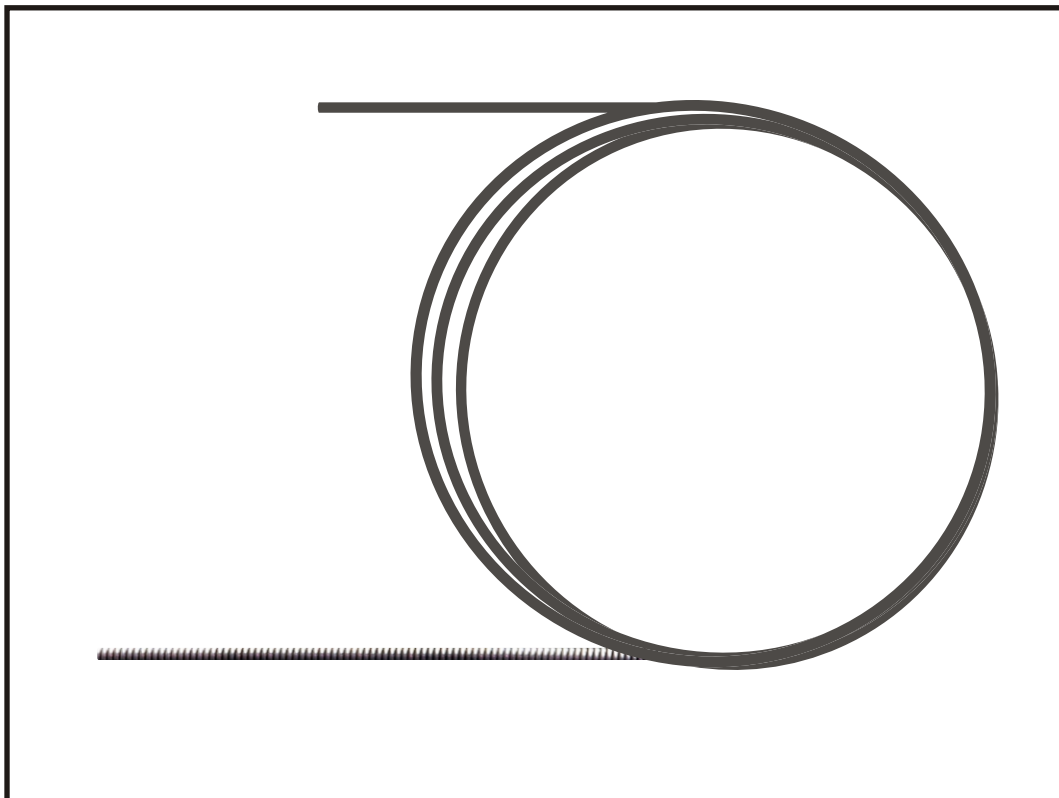

Ordering Information : Mention the product code x quantity required.

Reference	Product Name
S-SGW-035-S-150	Stiff Guide Wire 0.035 Straight

Tailormade device can be produced provided by pre approved drawing/ specification

Stone Basket

Indicated for the manipulation and removal / retrieval of ureteral stones from the bladder, renal pelvis and ureter.

Technical Information

Sheath Diameter - 1.8 fr, 2.4 fr, 3 fr, 4 fr & 5 fr

Availability - Individually packed.

Sterile For single use only.

Length - Custom

Type - Helical = H / Tipless = T / Straight = F / Tipless Helical = TH

Wire Qty. - 3/4/5 wires.

With Dismantle facility

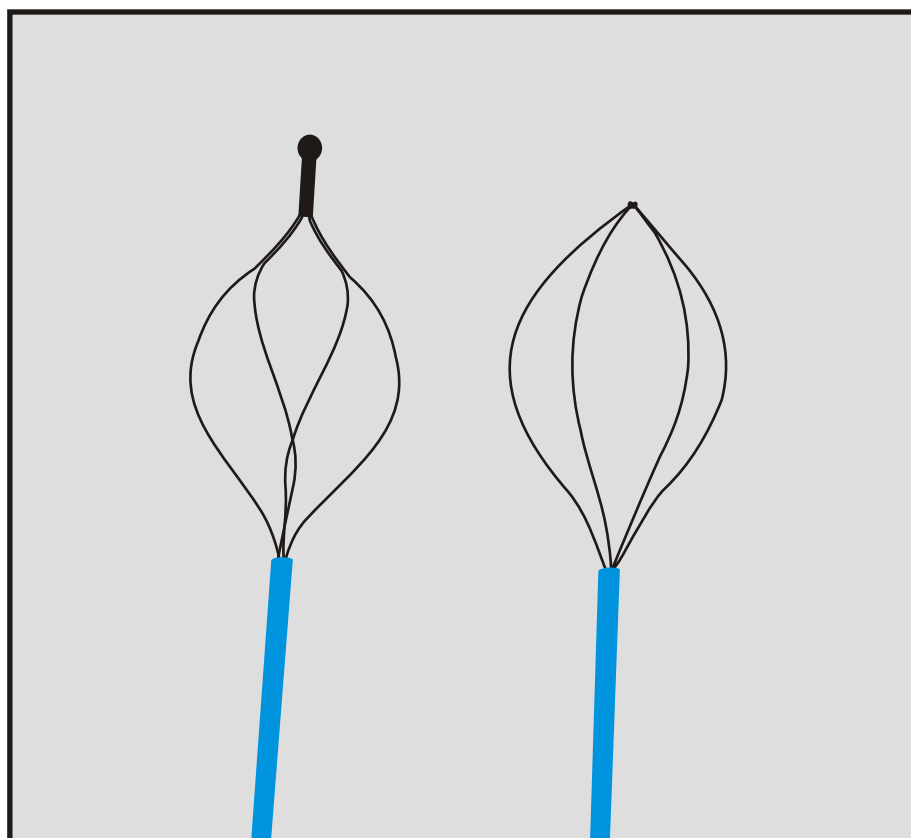

Ordering Information :

Reference : SEMB - Size Diameter - Wire Qty. - Length - Shape

For Example : If you want 3fr., 4 wire, 90cm, Tipless

Order Ref. No. is SEMB - 3490 - T

Tailormade device can be produced provided by pre approved drawing/ specification

Stone Grasper

Used to facilitate endoscopic manipulation / removal of stones and retrieval of foreign objects. Can also be used for removing stents through either rigid or flexible cystoscopy.

Technical Information

Sheath Diameter - 3 fr / 4 fr / 5 fr / 7 fr

Availability - Individually packed.

Sterile For single use only.

Length - As per Customer Requirement

Type - 3 Prong

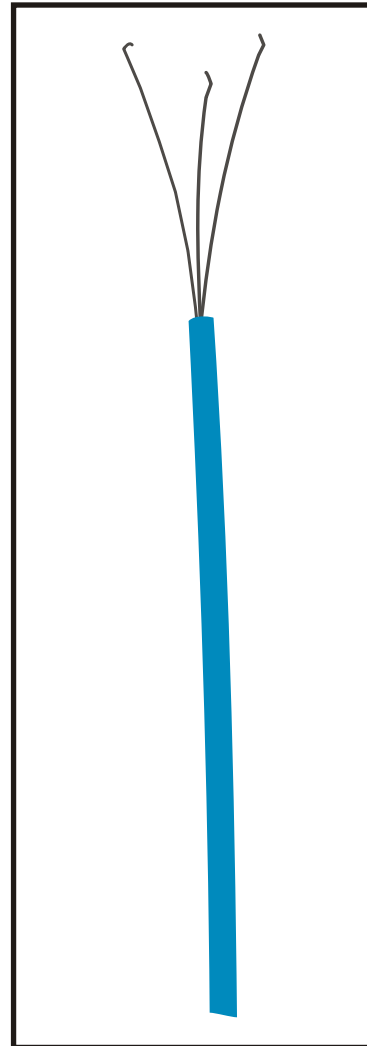

Ordering Information : Mention the product code x quantity required.

Reference	Product Name	Size
S-SG-3XLENGTH	Stone Grasper - 3 Nail	3 fr
S-SG-4XLENGTH	Stone Grasper - 3 Nail	4 fr
S-SG-5XLENGTH	Stone Grasper - 3 Nail	5 fr
S-SG-7XLENGTH	Stone Grasper - 3 Nail	7 fr

Tailormade device can be produced provided by pre approved drawing/ specification

Nephrostomy Basket & Probe

Technical Information

Sheath Diameter - 2.5 mm.

Availability - Individually packed.

Sterile For single use only.

Probe Diameter - 0.8 mm / 1.0 mm / 1.5 mm

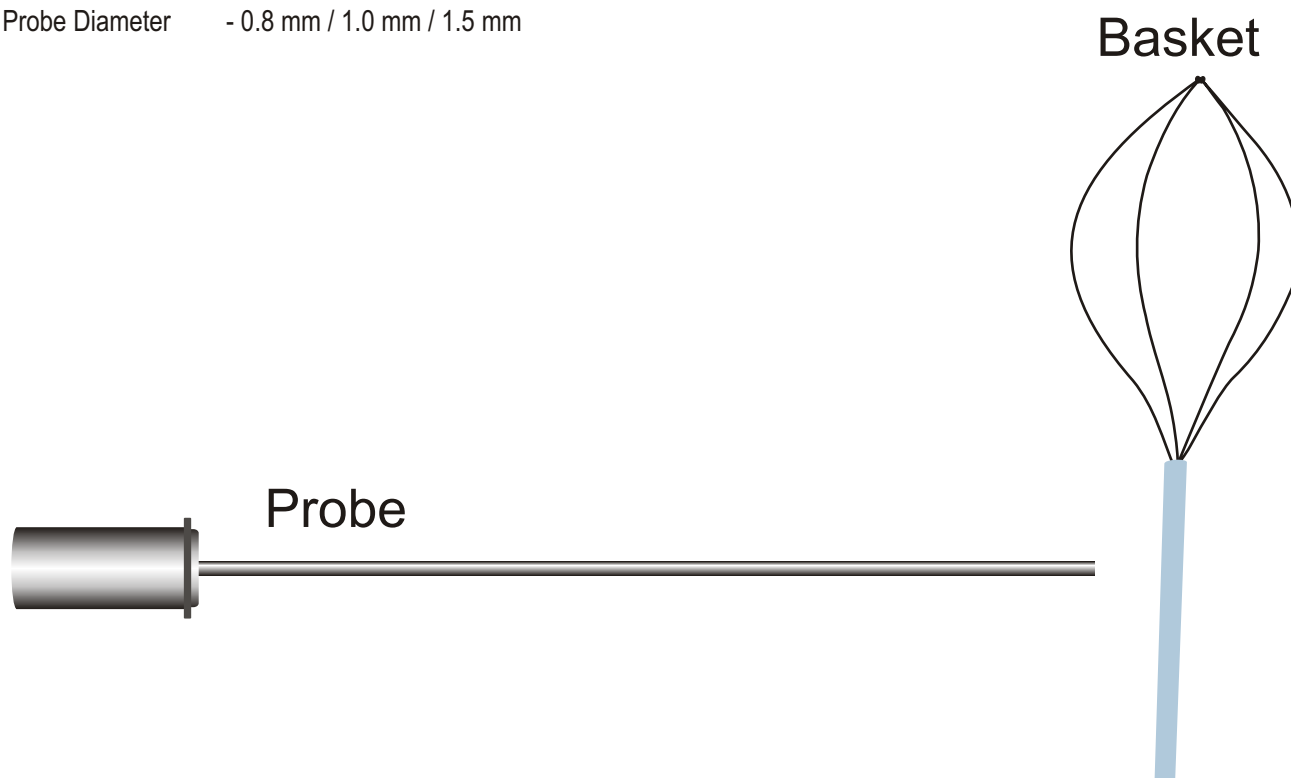

Ordering Information :

Reference	Product Name	Sheath Diameter
S-NB-54-H	Nephrostomy Basket	2.5 mm.
S-NP-08	Nephrostomy probe	0.8 mm.
S-NP-10	Nephrostomy probe	1.0 mm.
S-NP-15	Nephrostomy probe	1.5 mm.

Gynaecology

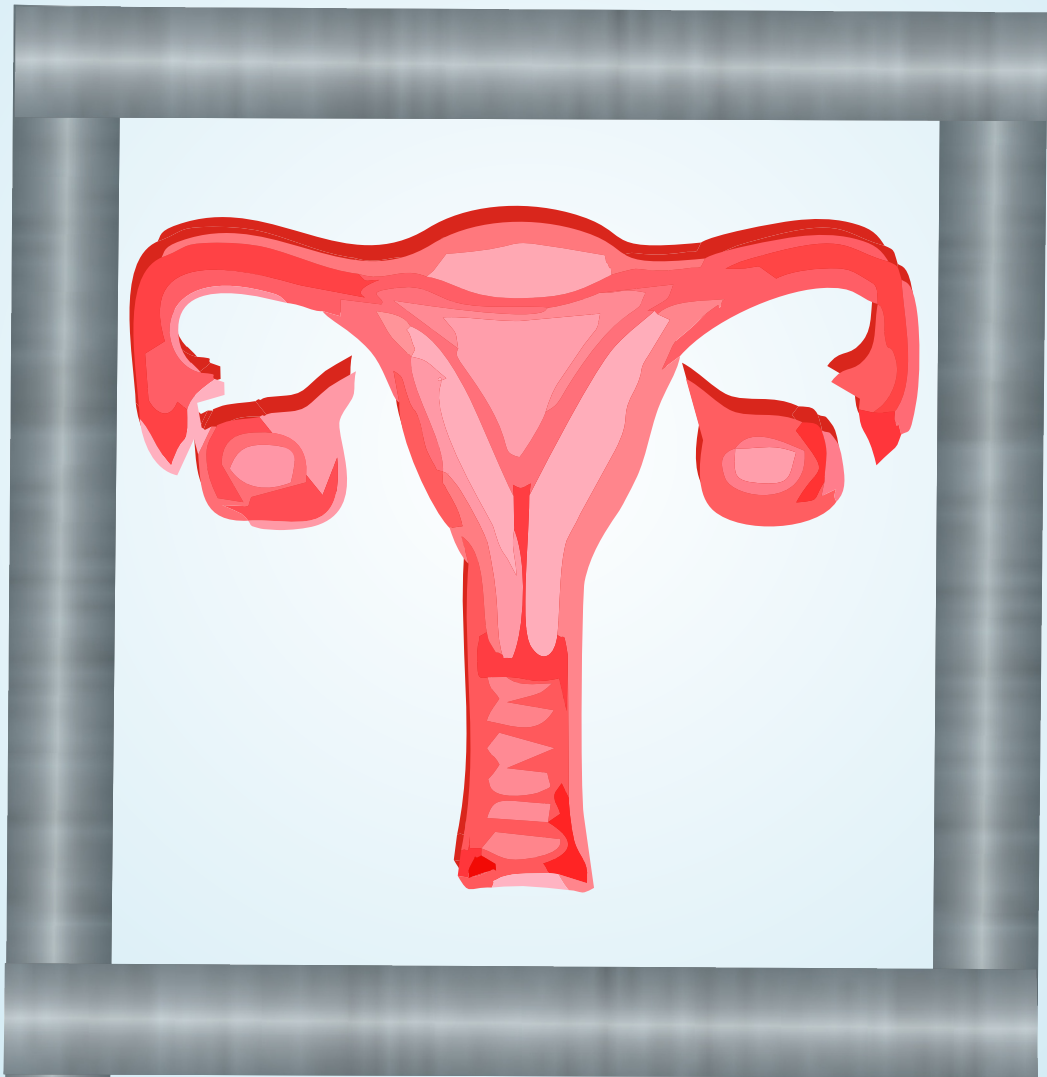

Cornual Cannulation Set



Used for Ovarian Cannulation

Technical Information :

Cathater diameter - 5fr.

Length - 50cm

Shape - Preshaped

Guide Wire - 0.025"

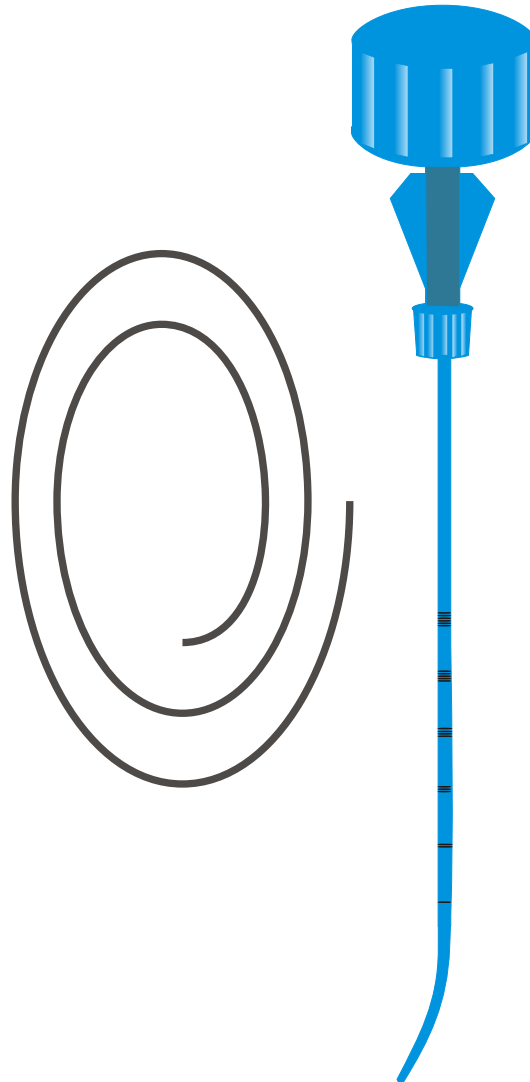

Ordering Information- Mention the product code x quantity required.

Reference	Product Name
SCCS	Cornual Cannulation Set Without Guide Wire
SCCS-G-NEG	Cornual Cannulation Set With Neg Guide Wire
SCCS-G-NITI	Cornual Cannulation Set With Nitinol Black Wire